

Underground Distribution

## Fuse Service Equipment

# Series 6 House Service Cut-outs (SNE) 240V/415V

Compliant to BS 7657: 2010, the well-established Series 6 range sets the standard for safety and convenience, for 240/415V House Service Cut-outs. It is especially suited to Separate Neutral and Earth (SNE) Systems.

Simple to install, the range comprises a single-pole and a single-pole-and-neutral and Earth model. The Cut-outs may be combined to form triple pole sets. All models can be rated up to 100A.

Socket-headed terminal screws (operated by a custom designed screwdriver) give positive engagement every time. In addition, all the phase terminal screws are held captive in the base of each unit.

As an alternative to fitting a fuselink, we can provide a solid link version, which is denoted by a red coloured carrier.

Sharply serrated double entry phase and neutral terminals are suitable for Aluminium or Copper conductors up to 35mm<sup>2</sup>.

Fuse-clips are precision designed to ensure low contact resistance every time.

The busbarring in of new supplies is quick, safe and simple with our uniquely designed Busbar, which interconnects via the incoming cable entry ports of each unit.

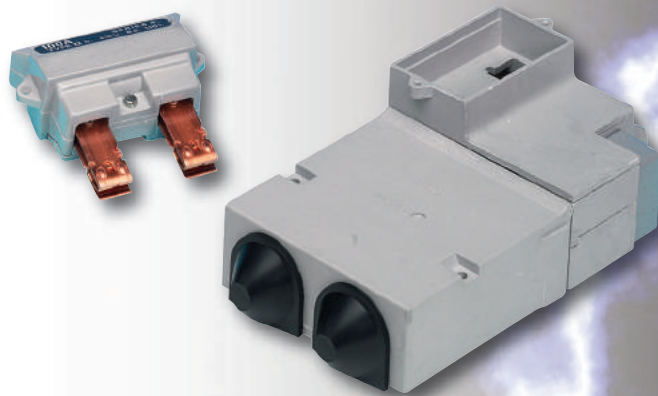

- Glass Reinforced Polyester (GRP) mouldings give high mechanical strength and will neither support combustion or track at working voltage.
- Busbarring facilities by means of an insulated Busbar which interconnects via the cable entry ports.
- CNE link, fitted in open position, closed by removing knockout between neutral and earth terminals and relocating link.

# Underground Distribution

## Fuse Service Equipment

Description	Product Code	
Single Pole Cut-out	<b>60/80A</b> 54141-03	<b>100A</b> 54142-07
Single Pole and Neutral (with separate earth terminal & CNE link in open position)	54143-08	54144-04
<b>Protection Chambers (with 2 PVC Bushes and blank entries)</b>		
For Single Pole and Neutral and Earth set	54317-01	
For Triple Pole and Neutral and Earth set	54318-02	
<b>Accessories and Spares</b>		
2 way Busbar	54382-85	
Fuse Carriers	<b>60/80A</b> 54365-10	<b>100A</b> 54365-13
Insulated Hexagon Headed Screwdriver	53485-36	
Solid link in red carrier (used in place of fuselink)	54365-05	
<b>Fuselink</b> <b>BSHD 60269-3:2010, BS 88-3:2010</b>		
<b>16 x 22 x 57mm</b> <b>to suit 60/80A Carrier</b>	<b>16 x 30 57mm</b> <b>to suit 100A Carrier</b>	
30A 58332-04	30A	58332-30
60A 58333-07	60A	58333-11
80A 58334-08	80A	58334-04
100A 58334-09	100A	58334-06
<b>Isolator</b>		
Single Pole and Neutral and Earth (fitted with red solid link carrier)	54361-01	
<b>Maximum Cable Sizes</b>		
Phase and Neutral (incoming and outgoing)	35mm <sup>2</sup>	
Earth	25mm <sup>2</sup>	
Time switch	10mm <sup>2</sup>	

**Note:** For single-pole-and-neutral and triple-pole-and-neutral sets, the Cut-outs and protection chambers are supplied as separate items for on site assembly

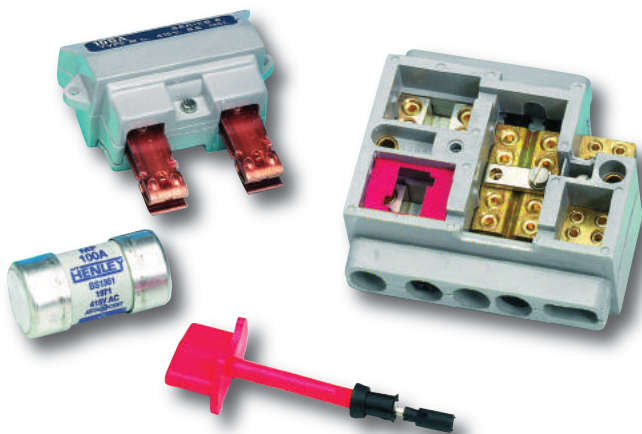

### Single Pole

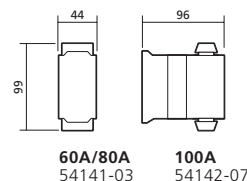

### Single Pole and Neutral and Earth Set

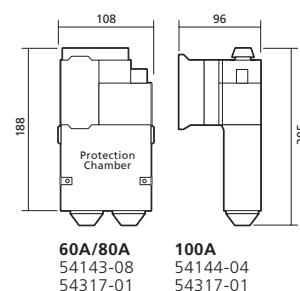

### Triple Pole and Neutral and Earth Set

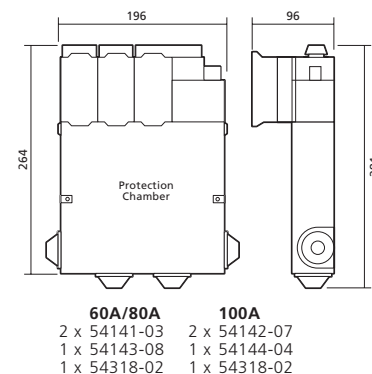

All dimensions in mm

### Fuselink to BSHD 60269-3:2010, BS 88-3:2010 for use with 60A/80A carrier

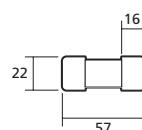

Fuselinks available  
from 20-80 amps

All dimensions in mm

### Fuselink to BSHD 60269-3:2010, BS 88-3:2010 for use with 100A carrier

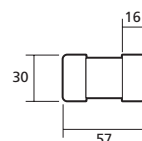

Fuselinks available  
from 30-100 amps

All dimensions in mm

**General Note:** The equipment in this publication should be installed by a suitably qualified person. Sicame UK Limited reserves the right to make changes in product specification without notice or liability. All information is subject to Sicame UK's own data and is considered accurate at time this document was created.

© 2014 Sicame UK Limited. All rights reserved. No part of this document may be copied or reproduced in whole or in part without prior written approval of Sicame UK Limited.

14688 2014-02-01

