

Product Code: CU2RCD80A

Description: 2 Pole 80A 30mA RCD

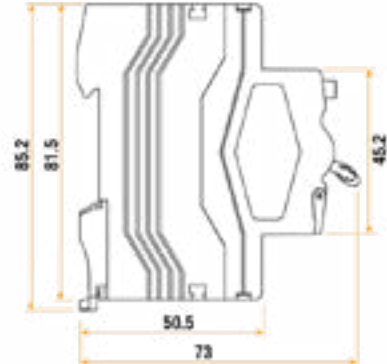

General Information

Dimensions (mm)	35,5 (W) x 85,2 (H) x 73 (D)
Finish	Light Grey (RAL 7035)
Frequency (Hz)	50/60
Maximum Rated Current (A) (In)	80
Impulse Withstand Voltage (Uimp)	4000
Type	A
Rated Making & Breaking Capacity (A) (Im)	800
Tripping Current (mA) (In)	30
Residual Non-Operating Current (IΔn)	0.5
Endurance Operations	2000 'ON' & 1000 'OFF' Cycles
Trip Type	Electro-Magnetic Release
Device Terminals	Screwed Lug & Pin
RCD Terminal Capacity (mm ²)	25
Number Of Poles	2 (1+N)
Ingress Protection	IP20
Operational Temperature (°C)	-25 to +40
Warranty (Years)	3
	RCD Terminal Torque (Nm) 2.5

Standards BS EN 61008-1

Additional Information For cleaning / polishing of products, use only a soft, dry, clean cloth.