

## TECHNICAL SPECIFICATIONS

### NC943B Single Zone Call Controller c/w Sounder

Mains supply: Voltage: 230Va.c. 50/60Hz; Max. current: 23mA.  
 Outputs: PSU voltage 12Vd.c. / current 140mA.  
 Volt-free relay contacts (NO/C/NC) rated 30Vd.c. @ 1A.  
 Currents: Zone current 18mA; Alarm current 23mA.  
 Battery backup: 500mA, rechargeable, 24 hours standby plus 15 minutes alarm run time.  
 Indicators: Red alarm 'Calling' LED; Green power 'On' LED (flashes green when battery backup is active).  
 Sounder: Active in alarm, volume adjustable.  
 Controls: 'Call Accept' button (link selectable for accept, reset, or no function).  
 IP Rating (EN 60529): IP31 when correctly installed.  
 Mounting: Mounts on 25mm UK double gang back box (flush or surface).  
 Dimensions: 147 x 87 x 39mm (W x H x D).  
 Weight: 300g  
 Operating Temp.: -5°C to +40°C; Max. relative humidity (RH) 95% non-condensing.

### NC807C Ceiling / Wall Pull Unit

Input: Voltage: 12Vd.c.; Connections: Signal and -Ve.  
 Pull cord: 3 metres cord length, generates an alarm call when activated.  
 Indicator: Red reassurance LED, active in alarm.  
 IP Rating (EN 60529): IP41 when correctly installed.  
 Mounting: Ceiling or wall surface mountable.  
 Dimensions: 93mm diameter x 27mm deep.

### NC806CS Overdoor Light c/w Sounder

Input: Voltage: 12Vd.c.; Connections: Signal, -Ve and +Ve.  
 Indicators: Dual ultra-bright red LEDs, active in alarm.  
 Sounder: Active in alarm.  
 IP Rating (EN 60529): IP41 when correctly installed.  
 Mounting: Mounts on 25mm UK single gang back box.  
 Dimensions: 87 x 87 x 68mm (W x H x D).

### NC809DBBT Accessible Toilet Reset Point c/w Sounder

Input: Voltage: 12Vd.c.; Connections: Signal, -Ve and +Ve.  
 Indicator: Red reassurance LED, active in alarm.  
 Sounder: Active in alarm.  
 IP Rating (EN 60529): IP41 when correctly installed.  
 Mounting: Mounts on 25mm UK single gang back box.  
 Dimensions: 87 x 87 x 24mm (W x H x D).

# 800 SERIES

E&OE. We reserve the right to alter product specifications at our discretion and without prior notice. This document has been carefully checked prior to publication. However, no responsibility can be accepted by the manufacturer or distributors of this equipment for any misinterpretation of an instruction or guidance note or for the compliance of the system as a whole.

# Accessible Toilet Alarm

This equipment must be installed and maintained by a suitably skilled and technically competent person.

This document provides a brief design and installation overview of the NC951 accessible toilet alarm system, based on the recommendations of BS 8300 (the code of practice for the design of buildings and their approaches to meet the needs of disabled people).

## NC951 KIT CONTENTS

### NC809DBBT Accessible Toilet Reset Point c/w Sounder

Includes a 'Reset' button c/w braille text, red reassurance LED and sounder.

### NC807C Ceiling / Wall Pull Unit

Includes a red reassurance LED, red pull cord and two triangular pull bangles.



**Accessory Pack**  
Containing device mounting screws and shorting link.

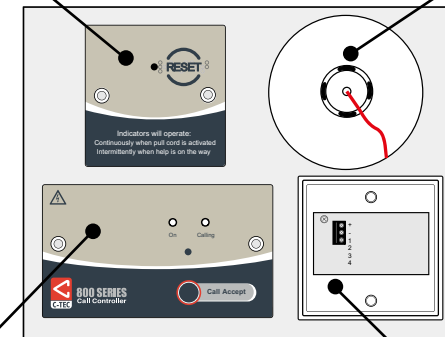

**NC949 Accessible WC Sticker**

**Documentation**  
A Design & Installation Guide (this document).

### NC943B Single Zone Call Controller c/w Sounder

Includes a link selectable 'Call Accept'/'Reset' button, 'Calling' and power 'On' LEDs, 140mA PSU, backup battery, volt-free relay output and sounder.

### NC806CS Overdoor Light c/w Sounder

## Single Zone Emergency Assistance Alarm



# QUICK START INSTALLATION GUIDE

Figure 1 below, summarises key information provided in this document. For experienced installers, this should be all you need to get started. NC951 components can be wired in any order. If in doubt, or if using this equipment for the first time, read the full document.

Figure 1 : Typical NC951 Accessible Toilet Alarm Wiring

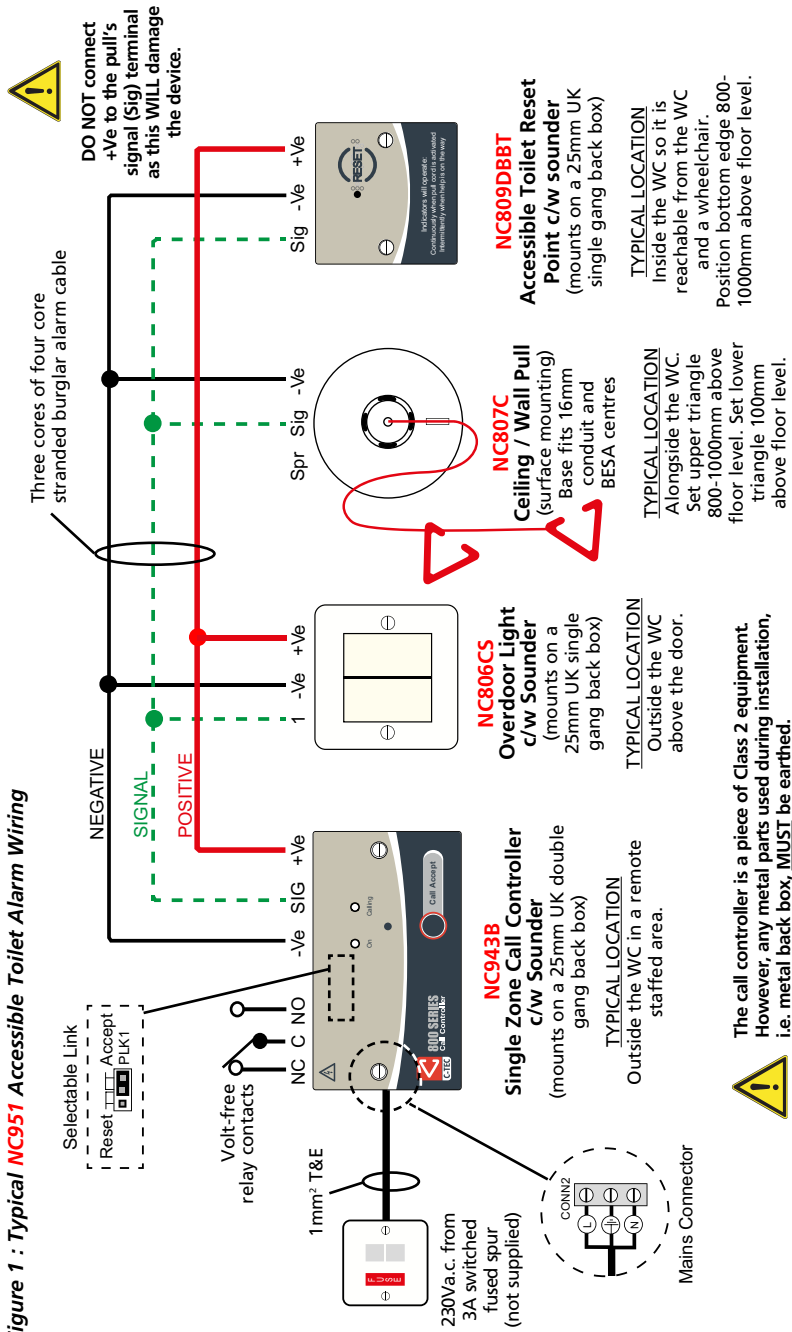

**The call controller is a piece of Class 2 equipment. However, any metal parts used during installation, i.e. metal back box, MUST be earthed.**

## BASIC OPERATION

The default operation of the NC951 is shown in the diagrams below.

### Raising an alarm call

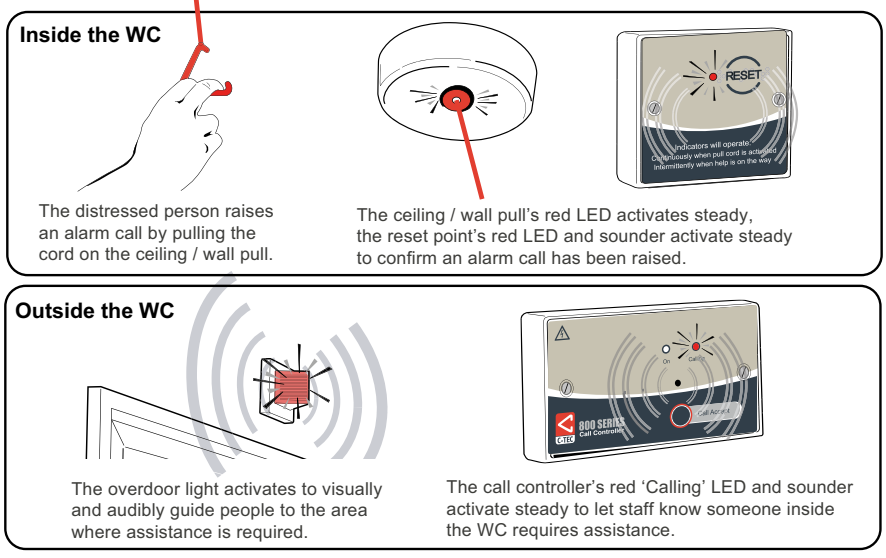

**Note:** The call controller's on-board relay will also activate when an alarm call is made and any external equipment connected to the relay contacts will operate as configured.

### Accepting an alarm call and resetting the system

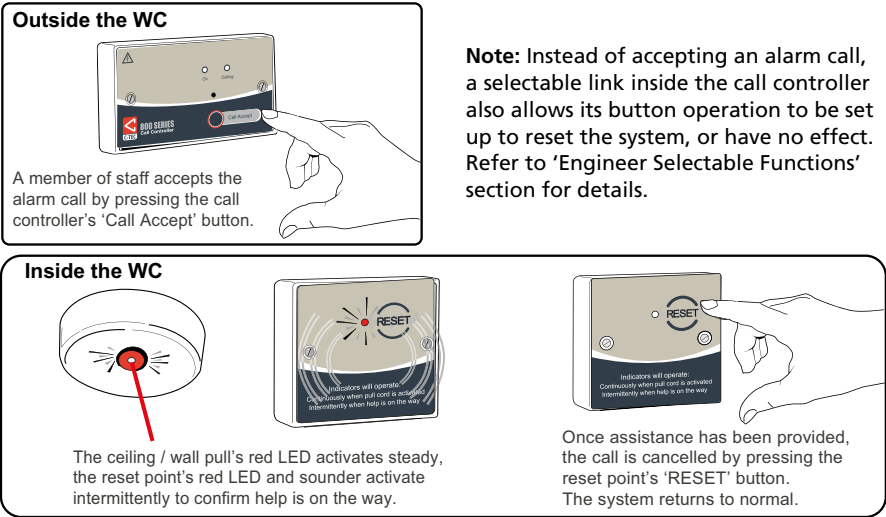

### Battery backup enable/disable (link PLK2)

Link PLK2 (supplied) enables or disables the call controller's battery backup facility. When enabled (link PLK2 fitted), the battery backup supply will continue to power the system for approximately 24 hours (standby) plus 15 minutes (alarm running time) in the event of a mains failure. This will be indicated by the call controller's power 'On' LED flashing green.

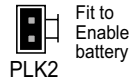

Should the mains supply remain disconnected for a prolonged period of time, the battery backup facility will automatically shutdown to prevent the batteries from deep discharge.

**Note:** PLK2 is not fitted in the call controller when dispatched. This is to conserve battery life and ensure the safety of the call controller during storage/transit.

### Volume control (potentiometer VR1)

Turn VR1 clockwise to increase (or anti-clockwise to decrease) the volume of the call controller's on-board sounder.

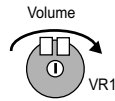

### Sounder and LED test facility

With no calls on the system, pressing the call controller's 'Call Accept' button with link PLK1 fitted in the Reset (b) position will cause all of the system's sounders and LEDs (apart from the ceiling / wall pull's LED) to activate. When the button is released, the LEDs and sounders will switch off. The same test can be carried out by pressing the reset point's 'RESET' button.

## EXPANDING THE SYSTEM WITH OPTIONAL EMERGENCY CALL LEVEL

Up to three additional 800 Series devices (any device mix) can be connected to the NC943B call controller. A typical expanded system is shown in figure 4 below. Should you wish to connect more than three additional devices, consider using an NC941 single zone call controller which is designed for powering larger call systems.

If required, the call controller can be used to generate a more urgent level of call. One compatible device is the NC804DE emergency call point (shown below). This device is typically used to allow the person attending the call to request additional assistance. When an emergency call is triggered, any active or accepted alarm calls will be overridden. The call controller's red 'Calling' LED will flash, its sounder (and relay) will pulse and the overdoor light will also pulse.

Figure 4 : Typical Expanded NC951 System with Emergency Call

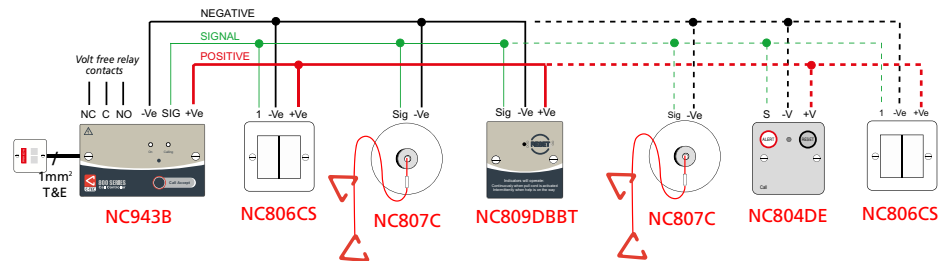

## DESIGNING AN ACCESSIBLE TOILET ALARM SYSTEM

Figure 2 below, shows a typical 'good practice' corner WC layout for an accessible toilet alarm system based on the recommendations of BS 8300 and the Building Regulations Approved Document Part M. Always refer to the full version of these documents before system design and installation. Refer to figure 1 (page 2) for wiring details.

Figure 2 : Typical Accessible Toilet Alarm System for a Corner WC

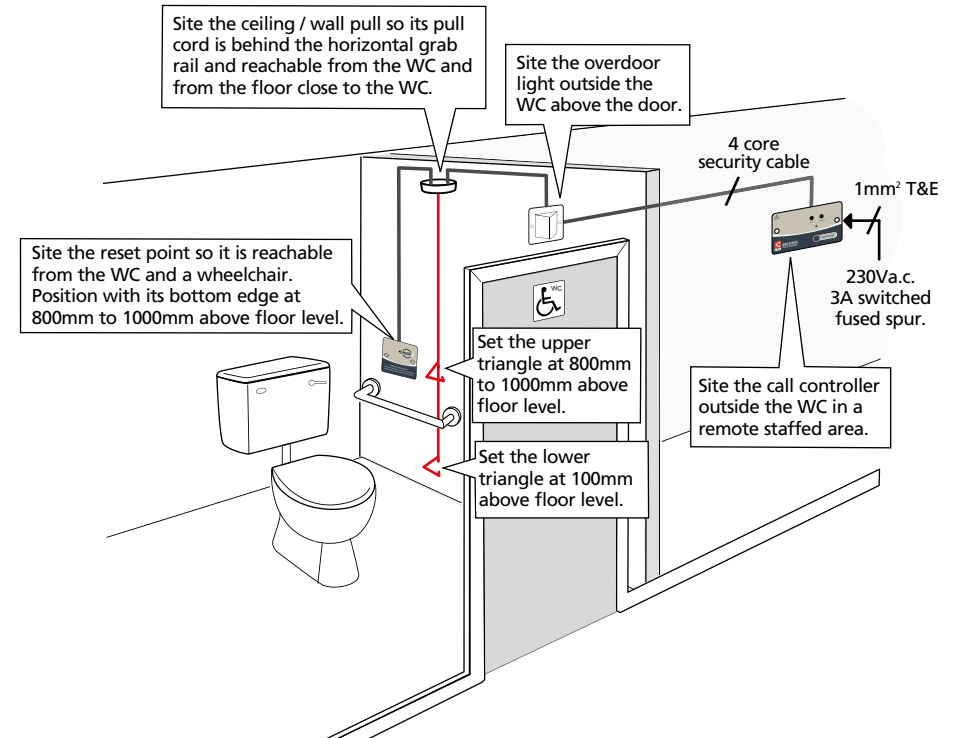

## INSTALLING THE ACCESSIBLE TOILET ALARM SYSTEM



ALWAYS ENSURE MAINS SUPPLY IS ISOLATED BEFORE MAKING ANY CONNECTIONS.

Refer to figure 1 (page 2) for wiring details.

### Mains wiring

All mains wiring should be provided in accordance with the current edition of the IEE Wiring Regs. (BS 7671) and/or other national wiring rules.

The general requirement for the mains supply to the NC943B call controller is fixed wiring, using three core cable of not less than 1mm<sup>2</sup>. This should be fed from an isolating switched fused spur, fused at 3A, which is marked appropriately and secure from unauthorised operation.

Live and neutral should be connected to the call controller's L and N terminals respectively. If a plastic back box is used, make the earth connection to the earth terminal at connector block CONN2. If a metal back box is used, the earth connection must be made to the earth bonding point on the back box.

### Extra low voltage (ELV) wiring

Always segregate ELV wiring from mains wiring.

Three cores of four core stranded burglar alarm cable is ideal for ELV wiring on most installations with all components requiring a positive, negative and signal connection (except the ceiling / wall pull which DOES NOT require a positive connection).

**Note:** The running order of the overdoor light, ceiling / wall pull and reset point can be changed to suit a specific application and/or to reduce wiring runs.

All wall-mounting devices (excluding pull units) should be mounted onto a back box of 25mm depth. Assess the condition and construction of all mounting surfaces prior to installation and use suitable screw fixings.

## ENGINEER SELECTABLE FUNCTIONS

The NC943B call controller has a number of engineer selectable functions (refer to figure 3 below). This section explains how these functions work and how to set them.

Figure 3 : Rear View of the NC943B Call Controller

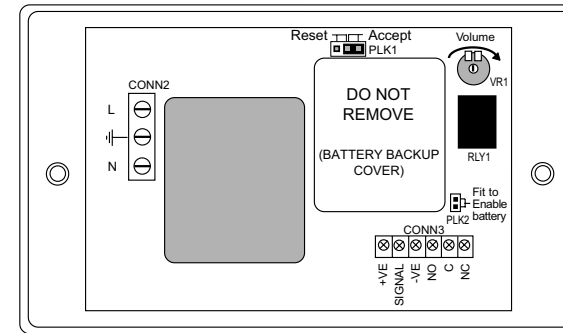

### 'Call Accept' button operation (link PLK1)

Link PLK1 (supplied) allows the call controller's 'Call Accept' button to be set up as follows when an alarm signal is raised:

#### (a) Accept the call

In this factory-fitted position, pressing the 'Call Accept' button will send a slow pulsing signal to the overdoor light and reset point. All sounders and LEDs will remain active until the reset point's 'RESET' button is pressed.



#### (b) Reset the system

In this position, pressing the 'Call Accept' button will cancel the alarm and return the system to its normal state.

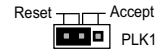

#### (c) Have no effect

With no link fitted, pressing the 'Call Accept' button signal will have no effect.



**Note:** It is recommended the call controller's button is set up to 'Call Accept' operation, which is the factory setting. 'Reset' and 'no effect' operations are outside the scope of BS 8300 and therefore not recommended for use in accessible toilet alarm installations. However, they may be suitable for use in other applications subject to the approval of the responsible person(s).

### Volt-free relay operation (RLY1)

The call controller includes an on-board volt-free relay with contacts rated 30Vd.c. @ 1A. This relay can be used to switch optional externally powered devices such as sounders, strobes, or the extra low voltage coils of mains controlling relays.

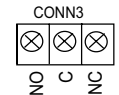

When no calls are on the system, the normally closed contact is made. When an alarm signal is present, the relay switches and the normally open contact is made.