

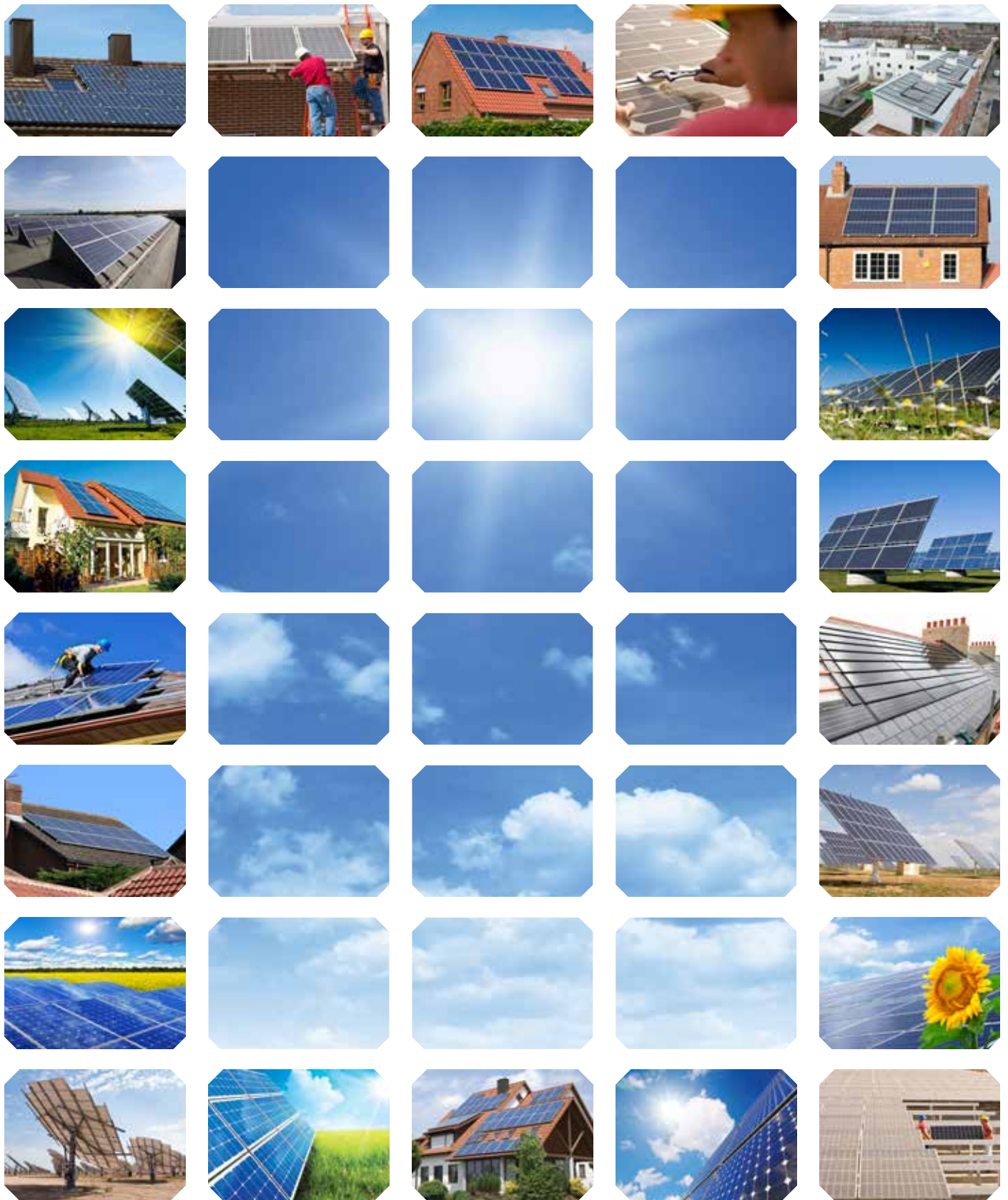

*"Brighter Solutions"*  
**Solar  
Product Range**



IMO is at the forefront of control component technology specifically developed for the renewable energy market and in particular solar energy. Whether meeting the demands of safe and efficient DC switching or delivering tracking solutions that help to maximise solar energy conversion rates, you can be sure that IMO products have been developed to meet the highest technical and commercial standards.



*"Keeping Solar Safe"*

# Contents

|  | Page      |
|--|-----------|
| <b>IMO Solar Guide - Abbreviations</b> | <b>4</b>  |
| <b>Introduction to PV Design</b>       | <b>5</b>  |
| <b>SI Range DC Isolators</b>           | <b>12</b> |
| Ordering Variations                    | 13        |
| Part Number Configuration              | 13        |
| Switching Configurations               | 14        |
| Technical Data                         | 15        |
| Dimensions                             | 33        |
| <b>SIM Range DC Isolators</b>          | <b>38</b> |
| Ordering Variations                    | 39        |
| Part Number Configuration              | 39        |
| Switching Configurations               | 40        |
| Technical Data                         | 41        |
| Handle Options                         | 48        |
| Dimensions                             | 49        |
| <b>Distribution/String Boxes</b>       | <b>52</b> |
| <b>Enclosed AC Isolators</b>           | <b>53</b> |
| <b>Solar Panel Rapid Shutdown</b>      | <b>54</b> |
| <b>Solar Tracker &amp; Measurement</b> | <b>56</b> |
| <b>Solar Relays</b>                    | <b>58</b> |
| <b>PV Rated DIN Rail Terminals</b>     | <b>59</b> |

# IMO Solar Guide - Abbreviations



|  |   |
|--|---|
| <b>AC</b>  | Alternating Current   |
| <b>DC</b>  | Direct Current  |
| <b><math>I_e</math></b>                                  | Rated Operational Current   |
| <b>IMO</b>   | IMO Precision Controls  |
| <b><math>I_{sc}</math></b>                               | Short-Circuit Current   |
| <b><math>I_{th}</math></b>                               | Thermal Current   |
| <b>MPPT</b>  | Maximum Power Point Tracking  |
| <b>PV</b>  | Photovoltaic  |
| <b><math>V_{oc}</math></b>                               | Open-Circuit Voltage  |
| <b>References</b>  |   |
| <b>BS 7671</b>   | Requirements for Electrical Installations   |
| <b>IEC/EN 60364-7-712</b>                                | Low-voltage electrical installations. Part 7-712: Requirements for special installations or locations. Photovoltaic (PV) power systems            |
| <b>IEC/EN 60529</b>                                      | Specification for degrees of protection provided by enclosures (IP code)  |
| <b>IEC/EN 60947-1<br/>UL 60947-1</b>                     | Low-voltage switchgear and controlgear. Part 1: General rules   |
| <b>IEC/EN 60947-3<br/>UL 60947-3</b>                     | Low-voltage switchgear and controlgear. Part 3: Switches, disconnectors, switch-disconnectors and fuse-combination units                          |
| <b>UL 60947-4-1</b>                                      | Low-voltage switchgear and controlgear. Contactors and motor-starters. Electromechanical contactors and motor-starters                            |
| <b>IEC/EN 61215</b>                                      | Crystalline silicon terrestrial photovoltaic (PV) modules – Design qualification and type approval  |
| <b>IEC/EN 61646</b>                                      | Thin-film terrestrial photovoltaic (PV) modules - Design qualification and type approval  |
| <b>Nema 250</b>  | Enclosures for Electrical Equipment (1000 Volts Maximum)  |
| <b>UL 94</b>   | Standard for Tests for Flammability of Plastic Materials for Parts in Devices and Appliances  |
| <b>UL 508</b>  | Industrial Control Equipment  |
| <b>UL 508i</b>   | Manual Disconnect Switches intended for use in Photovoltaic Systems   |
| <b>DTI/Pub URN 06/1972</b>                               | Photovoltaics in Buildings, Guide to the installation of PV systems 2nd Edition   |
| <b>Guide to Installation of PV Systems – 3rd Edition</b> |   |
| <b>Other Relevant References</b>                         |   |
| <b>G83/1-1</b>   | Recommendations for Connection of Small-scale Embedded Generators (Up to 16A per Phase) in Parallel with Public Low-Voltage Distribution Networks |
| <b>G59/2</b>   | Recommendations for the Connection of Generating Plant to the Distribution Systems of Licensed Distribution Network Operators                     |
| <b>NFPA70 2017</b>                                       | National Electrical Code  |

# Introduction to PV design

A Photovoltaic (PV) power system primarily converts sunlight directly into electricity using a photovoltaic cell array. The conversion of the solar radiation into electric current is carried out using the photoelectric effect found when some semiconductors that are suitably “doped” generate electricity when exposed to solar radiation.

As an individual PV-cell gives a relatively low output, a number of PV-cells are connected in series to supply higher voltages and connected in parallel in order to offer higher current capability. These cell arrays are referred to as PV-panels, and a number of interconnected panels are referred to as PV-strings. If there is a requirement for increased capacity then a larger system can be constructed whereby the PV-strings are connected in parallel to form a PV-array that gives a DC output current equivalent to the sum of all the PV-string outputs.

The main advantages of photovoltaic (PV) electricity generation are as follows:

- no fossil fuel usage and subsequent emission of pollution
- no nuclear fuel usage and disposal or storage of radioactive materials
- local distributed generation where needed
- installed system reliability and extended life
- reduced operating and maintenance costs
- ease of upgrading and replacement if necessary due to modularity of installation

When considering PV panels it is important to ensure that the units comply with all relevant standards for both electrical performance and for building requirements. It is recommended that, where possible, they comply with either IEC 61215 or IEC 61646, depending upon the structure of the cells. Once chosen the panels should be mounted in a location that maximises their exposure to sunlight for as long as possible and limits the possibility of shading, or future potential shading.

An inverter should be chosen to match the overall power capacity of the PV array, and like the arrays, it should operate as efficiently as possible. When considering the inverter, one using a Maximum Power Point Tracking (MPPT) system is preferential as this is a technique that grid connected inverters use to get the maximum possible power from one or more photovoltaic devices.

Where the PV installation is tied into the domestic grid system then the rules and procedures designated in G83 should be referred to and followed by a competent installer who is associated with a suitable accreditation scheme such as MCS.

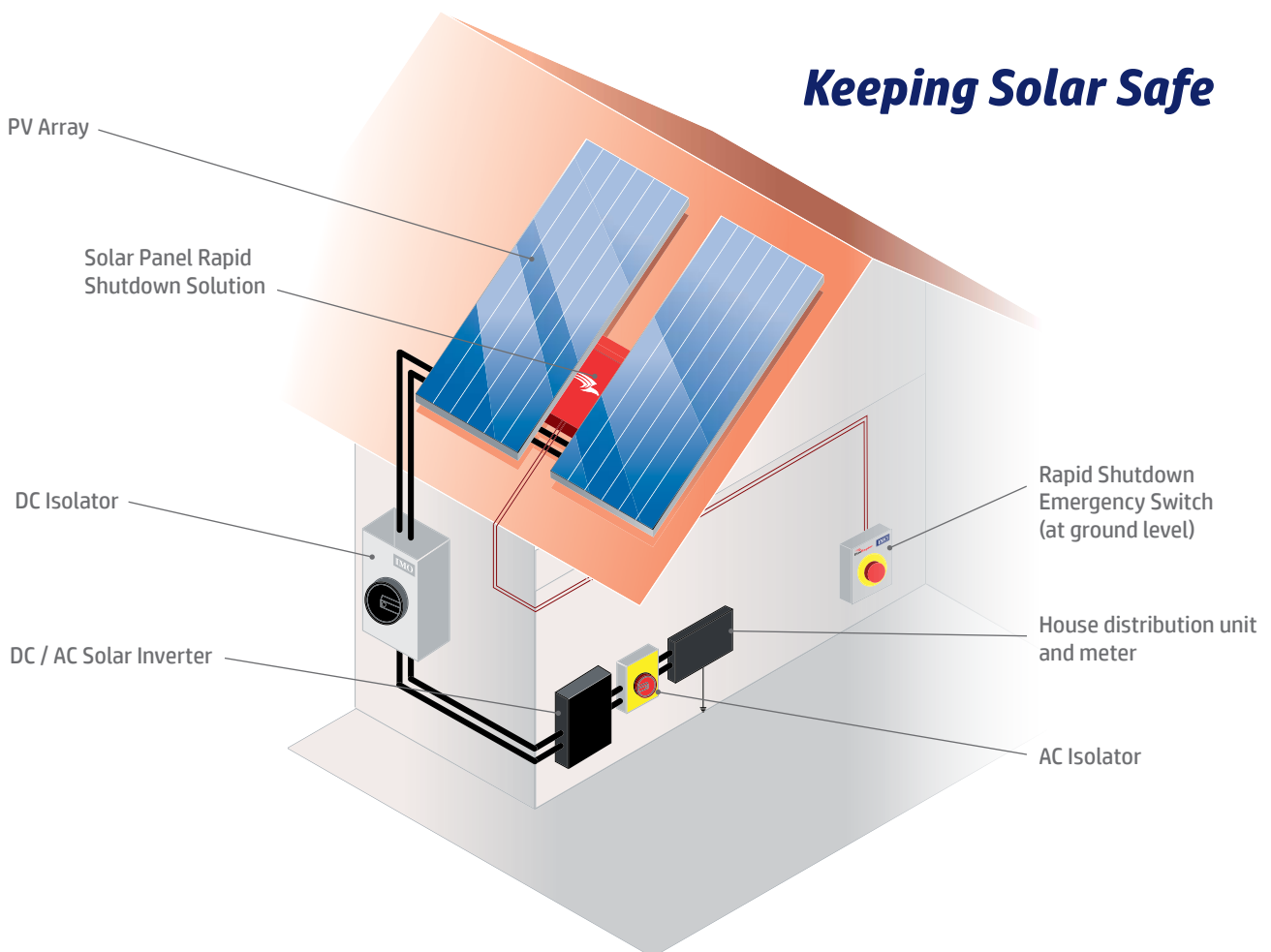

## Utilisation Categories

Utilisation Categories as are covered in the European Standards EN 60947-1 & EN60947-3 and define an equipment's intended application. The list of both AC and DC categories for low-voltage switchgear and controlgear are stated in EN 60947-1 Annex A along with the relevant product standards.

Manufacturers of both switchgear and controlgear should include in their technical product data all the operational ratings for the utilisation categories for which a product is designed and as such this should remove the confusion for users and designers in their selection of the correct product.

If we consider PV installations where there are requirements for switchgear being used on the DC side then the system falls typically within two categories below (for which the relevant standard is EN 60947-3)

**DC-21 Switching of resistive loads, including moderate overloads**

**DC-22 Switching of mixed resistive and inductive loads, including moderate overloads**

**DC-PV1 Switching of single PV string(s) without reverse and overcurrents**

**DC-PV2 Switching of several PV strings with reverse and overcurrents**

Compliance to the EN60947-3 utilisation categories involves the products completing a number of tests, these include the "Making and Breaking Capacity" (section 7.2.4.1/D7.2.4.1) and "Operational Performance" (section 7.2.4.2/D7.2.4.2). Verification of the operational making and breaking capacities are stated by reference to the rated operational voltage and rated operational current according to Table 3 and Table D7 (see extracts below).

### Test Conditions for Making & Breaking Capacities

| Utilisation categories | Rated operational categories | Making  |         |        | Breaking  |           |        | Number of operating cycles |
|------------------------|------------------------------|---------|---------|--------|-----------|-----------|--------|----------------------------|
|                        |                              | $I/I_e$ | $U/U_e$ | L/R ms | $I_c/I_e$ | $U_c/U_e$ | L/R ms |                            |
| DC-21A - DC-21B        | All values                   | 1.5     | 1.05    | 1      | 1.5       | 1.05      | 1      | 5                          |
| DC-22B                 | All values                   | 4       | 1.05    | 2.5    | 4         | 1.05      | 2.5    | 5                          |
| DC-PV1                 | All values                   | 1.5     | 1.05    | 1      | 1.5       | 1.05      | 1      | 5                          |
| DC-PV2                 | All values                   | 4       | 1.05    | 1      | 4         | 1.05      | 1      | 5                          |

### Test Conditions for Number of On Load Operating Cycles

| Utilisation categories | Number of operating cycles per hour | Number of operating cycles |              |        |                 |              |       |
|------------------------|-------------------------------------|----------------------------|--------------|--------|-----------------|--------------|-------|
|                        |                                     | A categories               |              |        | B categories    |              |       |
|                        |                                     | Without current            | With current | Total  | Without current | With current | Total |
| DC-21A/B & DC-22B      | 120                                 | 8,500                      | 1,500        | 10,000 | 1,700           | 300          | 2,000 |
| DC-PV1 & DC-PV2        | 120                                 | 9,700                      | 300          | 10,000 | -               | -            | -     |

| Utilisation categories | Rated operational categories | Making  |         |        | Breaking  |           |        |
|------------------------|------------------------------|---------|---------|--------|-----------|-----------|--------|
|                        |                              | $I/I_e$ | $U/U_e$ | L/R ms | $I_c/I_e$ | $U_c/U_e$ | L/R ms |
| DC-21A - DC-21B        | All Values                   | 1       | 1       | 1      | 1         | 1         | 1      |
| DC-22B                 | All Values                   | 1       | 1       | 2      | 1         | 1         | 2      |
| DC-PV1                 | All Values                   | 1       | 1       | 1      | 1         | 1         | 1      |
| DC-PV2                 | All Values                   | 1       | 1       | 1      | 1         | 1         | 1      |

$I$ =making current     $I_c$ =breaking current     $I_e$ =rated operational current  
 $U$ =applied voltage     $U_e$ =rated operational voltage     $U_r$ =operational frequency or d.c recovery voltage

## PV Installation Isolation

PV installations consist of the DC side, the Inverter and the AC side with isolation required for both the PV-array to the inverter and for the AC supply from the load, particularly where the system is connected to the Distributed Network, this is a stipulation in G83/1. In some instances the “Guide to Installation of PV Systems” allows inverter and DC string isolation to be provided by the same device, for example the PV plug and socket connectors, but this is only deemed suitable for smaller systems and the connectors must be labelled appropriately. Generally IMO would always recommend the use of a suitably rated DC isolator.

## DC Isolator Selection

BS 7671 states that a method of isolation must be provided on the DC side of a PV installation and this can be provided by a switch-disconnector as classified under EN 60947-3 this is also covered by “Guide to the installation of PV systems”. The Guide also stipulates that the switch must isolate all live conductors (typically double pole to isolate PV array positive and negative conductors).

BS 7671 specifies that isolators that are in compliance with EN 60947-3 are appropriate for use in PV systems. The isolator rating must consider the maximum voltage and current of the PV string being switched and these parameters then adjusted in accordance with the safety factors stipulated in current standards. This should then be the minimum required rating of the isolator.



$$\text{Voltage} = N_s \times V_{oc} \times 1.15 \quad \text{Current} = N_p \times I_{sc} \times 1.25$$

$N_s$  - Number of panels connected in series  
 $V_{oc}$  - Open-Circuit Voltage (from module manufacturer's data)

$N_p$  - Number of strings connected in parallel  
 $I_{sc}$  - Short-Circuit Current (from module manufacturer's data)

The isolator should also be suitable for use in the appropriate application which in PV installations is normally considered to be either DC-21A, DC-21B, DC-22A or DC-22B. Normally isolation of the DC supply from the inverter would not be a regular occurrence and therefore generally ratings for DC-21B or DC-22B would, as a minimum, be necessary; although category A types (as previously covered in Utilisation Categories) would be advantageous due to their capability of a higher number of switching operations, and therefore a longer guaranteed life.

## AC Isolator Selection

AC Isolators are used in both stand-alone grid or network distributed systems. If connected to the distributed network then G83/1 stipulates the PV system must be connected directly to an isolation switch that is wired so as to isolate both the live and neutral conductors, capable of being secured in the “OFF” position and in an accessible location within the installation. In a stand-alone system IMO recommend that a lockable OFF isolation switch is similarly used within the installation. BS 7671 specifies that isolators that are in compliance with EN 60947-3 are appropriate for use in PV systems.

Unlike a DC isolator that is required to switch both the positive and negative conductors, an AC isolator should be chosen with regards to the supply being single phase, which is typically found in domestic installations or three phase, which is typical for commercial or industrial installations. Ideally for single phase a 2pole isolator should be used to switch the live and neutral line (earth constantly connected) whilst a 4pole isolator would be used to switch the 3 voltage lines and neutral (earth constantly connected).

The isolator rating should be based on the inverter output which is normally specified per phase, that is line to neutral, and for example maybe shown as 20A at 230VAC; if this output is from a three phase unit then the AC isolator must be rated to for the line-to-line voltage which would typically be 415VAC.

With both AC and DC isolators the ambient temperature of the environment in which the switch is mounted must be considered as most industrial switches are nominally rated for use in 35°C. However, if the isolator is to be used in an area where solar activity is prevalent, thereby making more efficient use of the installation and greater yield, or in an enclosed space such as a loft or that of an inverter enclosure, then an isolator capable of handling the elevated temperatures should be selected.

All IMO Solar Isolators are capable of being installed in areas where high ambient temperatures of up to +45°C can be found. In installations of higher temperatures, our open style product can be used up to +65°C, however, you should ensure safe operating conditions and correct mounting of the product.

## Why use an IMO DC Solar Isolator?

IMO Precision Controls offers a range of True DC Isolators specifically designed for use in Solar PV installations in accordance with EN 60364-7-712. The IMO design incorporates a user independent switching action so as the handle is moved it interacts with a spring mechanism which, upon reaching a set point, causes the contacts to “SNAP” over thereby ensuring a very fast break/make action. This mechanism means that the disconnection of the load circuits and suppression of the arc, produced by a constant DC load, is normally extinguished in 3ms using the specific pole suppression chambers incorporated within the design.

Many alternative solutions, particularly those based upon an AC isolator designs which use bridge contacts, have been modified and rated for DC operation. These types of product have a switching speed that is directly linked to operator speed therefore, slow operation of the handle results in slow contact separation of the contacts which can produce arcing times of 100ms or more. Also in these switches the contact surface is also the surface upon which arcs tend to form; therefore, any surface damage or sooting caused by the arcing is likely to have a detrimental effect on the isolator's contact resistance and its longevity.

The IMO Solar Isolator range is offered in a number of configurations all rated for installation and use as switch-disconnects and all with options allowing for "LOCKABLE OFF" operation. Although able to offer the industry standard two position 90° handle operation from LOCKABLE OFF-ON, IMO have also introduced a **SAFE-LOCK** patented handle that allows for three rotational positions relating to ON-OFF-LOCK. The facility offered by this design gives a LOCK position that is removed from the OFF setting ensuring the handle can be placed in its own unique position when locked, which is fully compliant with IEC 60947-1 section 8.2.5.2.1 for classification as an isolator or switch disconnect. When this design is used within the IMO enclosed Solar Isolators it ensures that engineering access can only be attained to the enclosure when the handle is in the OFF position; whilst the "LOCK" position ensures secure power isolation combined with non-access to the enclosure (when the isolator block is secured with supplied screws) and thereby significantly reducing the risks of tampering when maintenance/repair is carried out on equipment in-line after the isolator, **SAFE-LOCK**. Once any work has been undertaken the locking mechanism can then be removed and the isolator returned to its normal operational mode.



IMO Solar Isolators use a rotary "knife contact" mechanism so when the unit is operated the handle movement gives a double make/break per contact set. As DC load switching creates arcing the design is such that this only occurs on the corners of the switching parts meaning that the main contact is made on an area where no arcing has occurred. The rotary contact mechanism methodology used in the IMO Solar Isolators means that, when the isolator is operated, a self-cleaning action occurs on the arcing points and contact surfaces thereby producing good high vibration resistant contact integrity, with reduced contact resistance. This IMO contact system ensures that power loss per pole is kept as low as possible and consistent over the life of the product unlike conventional style isolators where entrapment of contaminants, and then subsequent compression on lateral operation, can lead to variable and increasing contact resistance and hence per pole losses.

As indicated in the section about **Utilisation Categories**, the IMO product is satisfactory for use in installations classified as either DC-PV1, DC-PV2, DC-21A, DC-21B or DC-22A, and so suitable for a high number of "off load" operations (without current) and also a high number of operating cycles "on load" (with current).



Unlike a number of DC isolators on the market, the IMO solar isolator is also polarity independent, which means that there is no requirement for specific directional wiring of the PV supply. A further advantage of the IMO contact mechanism is that, in the event of the supply to earth failure, the high short circuit current pulls the contacts together thereby giving a high short circuit withstand current of up to 2400A (product dependent). PV residential installations are typically 1000VDC however, IMO Solar Isolators already have the capability to operate up to 1500VDC.

In the move towards safer installations of PV systems, whether it be in a domestic or industrial environment, consideration has to often be given to the materials and the risk of fire hazard that they pose. Ratings referred to under the UL 94 category are deemed generally acceptable for compliance with this requirement as this cover tests for flammability of polymeric materials used for parts in devices and appliances. Although there are 12 flame classifications specified in UL 94, there are 6 which relate to materials commonly used in manufacturing enclosures, structural parts and insulators found in consumer electronic products. These are 5VA, 5VB, V-0, V-1, V-2 and HB.

## IMO DC Isolator Approvals

| Country           | RoHS<br>✓<br>RoHS | USA, UL508i<br>UL | US, CAN, UL60947-1<br>cULus | Europe CE<br>CE | CCC China<br>CCC | IEC CB Europe<br>IEC | ESV Australia<br>ESV |
|-------------------|-------------------|-------------------|-----------------------------|-----------------|------------------|----------------------|----------------------|
| SI16/SIM16/SIME16 | ✓                 | ✓                 | ✓                           | ✓               | ✓                | ✓                    | ✓                    |
| SI25/SIM25/SIME25 | ✓                 | ✓                 | ✓                           | ✓               | ✓                | ✓                    | ✓                    |
| SI32/SIM32/SIME32 | ✓                 | ✓                 | ✓                           | ✓               | ✓                | ✓                    | ✓                    |
| SI38/SIM38/SIME38 | ✓                 | ✓                 | ✓                           | ✓               | ✓                | ✓                    | ✓                    |
| SI40/SI55/SI65    | ✓                 | ✓                 | ✓                           | ✓               | ✓*               | ✓                    | ✓                    |

\* Please note that the SI65 does not have CCC approval for China



It is because of this that the IMO Solar Isolator range is constructed of materials that significantly reduce the risk of a fire hazard and in particular our enclosed installation style products for which the main plastic enclosure is rated at UL 94V-0 and the handles are UL 94V-2 rated. The classification criteria for each of these ratings is found in of the UL 94 Table 8.1 (see extract below).

| Criteria conditions  | V-0  | V-1   | V-2   |
|--|------|-------|-------|
| Afterflame time for each individual specimen t1 or t2  | ≤10s | ≤10s  | ≤30s  |
| Total afterflame time for any condition set (t1 plus t2 for the 5 specimens)                           | ≤50s | ≤250s | ≤250s |
| Afterflame puts afterglow time for each individual specimen after the second flame application (t2+t3) | ≤30s | ≤60s  | ≤60s  |
| Afterflame or afterglow of any specimen up to the holding clamp  | No   | No    | No    |
| Cotton indicator ignited by flaming particles or drops   | No   | No    | Yes   |

The installation requirements and environments of PV systems can vary significantly and the IMO Solar Isolator has been designed such that it can offer a wide range of configurations depending upon the users’ requirement. Also the IMO Solar Isolator range includes models that, when mounted in accordance with their respective instructions and with the appropriate IMO handle, offer suitable protection up to IP66 (EN 60529) and NEMA 4X (Nema 250, UL508).

With the advent of more worldwide installations and the requirements laid down in many country’s national wiring publications for the use of DC switches in PV installations, the IMO Solar Isolators have also been assessed and tested under the latest UL standard UL508i which has been specifically written to cover the use of “Manual Disconnect Switches intended for use in Photovoltaic Systems”.

This UL508i standard specifically covers switches rated up to 1500 V that are intended for use in an ambient temperatures of -20°C to +50°C, and that are suitable for use on the load side of PV branch protection devices. In order to comply with this standard the IMO DC Isolators has to pass an overload test, at +50°C, of 50 cycles at 200% of rated current; followed by an endurance test of 6000 cycles (6 cycles/min) at rated load (Ith) and a further 4000 cycles with no current.

The IMO DC Isolator has successfully attained certification under the UL508i standard and as such is suitable for use as a disconnection method for the isolation of the output of DC PV array where it is to be connected to a DC/AC inverter.

## Examples of Typical PV Installations

### Single String System – 3kW Output Single Phase

Consider two potential configurations for a typical 3kW system which would supply 13A at 230VAC:

|              |   |  |
|--------------|---|--|
| Inverter:    | Input: 600VDC ( $V_{OC}$ ), 16A ( $I_{DC}$ ), 32A ( $I_{DCmax}$ ) | Output: 230VAC ( $V_{AC}$ ), 13A ( $I_{AC}$ ), 17.2A ( $I_{ACmax}$ ) |
| Solar Panel: | 60V ( $V_{OC}$ ), 8A ( $I_{SC}$ )                                 | No. of panels: 8   |
| Calculation: | $V = 8 \times 60 \times 1.15 = 552V$ $I = 8 \times 1.25 = 10A$    |  |

For this configuration, the IMO SI16-PEL64R-2 rated at 16A for 700VDC is suitable for the DC switch and the PE69-3020 rated at 20A is suitable for the AC switch.

|              |  |  |
|--------------|--|--|
| Inverter:    | Input: 750VDC ( $V_{OC}$ ), 15A ( $I_{DC}$ ), 28A ( $I_{DCmax}$ )  | Output: 230VAC ( $V_{AC}$ ), 13A ( $I_{AC}$ ), 16A ( $I_{ACmax}$ ) |
| Solar Panel: | 60V ( $V_{OC}$ ), 8A ( $I_{SC}$ )                                  | No. of panels: 10  |
| Calculation: | $V = 10 \times 60 \times 1.15 = 895.62V$ $I = 8 \times 1.25 = 10A$ |  |

For this configuration, the IMO SI25-PEL64R-2 would still be suitable as it is rated at 16A for 800VDC, however the IMO SI25-PEL64R-2 rated at 16A for 900VDC would allow for a greater margin of safety. The PE69-3020 rated at 20A is suitable for the AC switch.

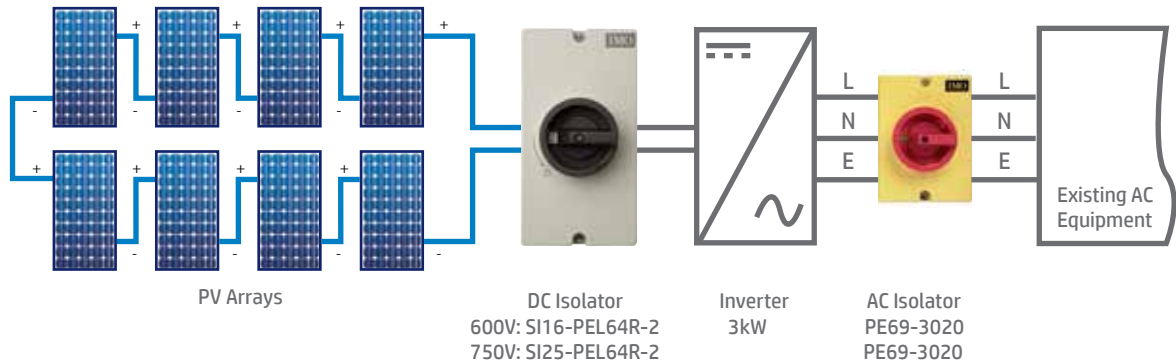

### Dual String System – 5kW Output Single Phase

Consider a typical 5kW system which would supply 22A at 230VAC:

|              |  |  |
|--------------|--|--|
| Inverter:    | Input (per string): 600VDC ( $V_{OC}$ ), 18A ( $I_{DC}$ ), 36A ( $I_{DC\ max}$ ) | Output: 230VAC ( $V_{AC}$ ), 25A ( $I_{AC\ max}$ ) |
| Solar Panel: | 64.9V ( $V_{OC}$ ), 6.46A ( $I_{SC}$ ), 5.98A ( $I_{mpp}$ ), 327Wp ( $P_{nom}$ ) | No. of panels: 8 per string                        |
| Calculation: | $V = 8 \times 64.9 \times 1.15 = 597.08V$ $I = 6.46 \times 1.25 = 8.08A$         |  |

For this configuration, each string is to be switched at these levels so the IMO SI16-PEL64R-4 rated at 16A for 700VDC per string is suitable for the DC switch and the PE69-3025 rated at 25A is suitable for the AC switch.

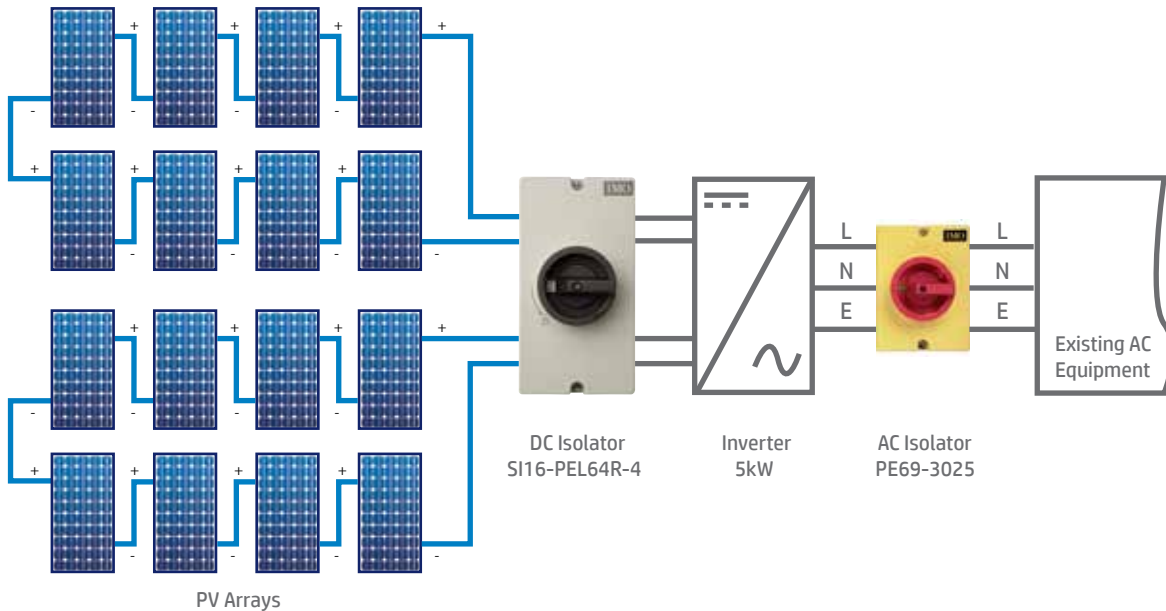

### High Voltage Multi-string System – 12.5kW Output Three Phase

|              |  |   |
|--------------|--|---|
| Inverter:    | Input (per string): 900VDC ( $V_{OC}$ ), 18A ( $I_{DC}$ ), 36A ( $I_{DC\ max}$ ) | Output: 4000VAC ( $V_{AC}$ ), 20A ( $I_{AC\ max}$ ) |
| Solar Panel: | 64.9V ( $V_{OC}$ ), 6.46A ( $I_{SC}$ ), 5.98A ( $I_{mpp}$ ), 327Wp ( $P_{nom}$ ) | No. of panels: 12 per string                        |
| Calculation: | $V = 12 \times 64.9 \times 1.15 = 895.62V$ $I = 6.46 \times 1.25 = 8.08A$        |   |

For this system there are several options to consider. If each string is to be switched individually then the SI25-PEL64R-2 rated at 11A for 1000VDC is suitable for the DC switch. If there is a requirement to isolate the strings as pairs then the SI25-PEL64R-4 is suitable. If all strings are to be isolated using one DC isolator then the IMO SI25-PEL64R-8 is suitable. The PE69-3025 rated at 25A is suitable for the AC switch in each case.

Alternatively, if the requirement is to still have the capability of isolating each string individually whilst retaining a single housing unit, then an IMO distribution box populated with SI25-DBL-2 is suitable. These devices use the same switch block as the SI25-PEL64R-2 so have the same rating of 11A at 1000VDC.

This document is meant as a guide and IMO Precision Controls shall not be liable in any event whatsoever for any indirect, special or consequential damages, arising out of the use of the products covered by this document at any time or howsoever caused by the goods. IMO Precision Controls excludes any warranty, condition or statement, express or implied, statutory or otherwise, as to quality, merchantability, or fitness of the goods for any particular purpose.

# Over 6 Million Installed Units **ZERO FAILURES**



In solar installation, the DC isolator is like a vehicle air-bag. You never know it really works until you need it. So it's good to know that the IMO SI has now surpassed six million installed units without a single recorded electrical failure.

Not surprising considering the product carries all the most important approvals including UL508i, IEC/EN 60947-1, UL 60947-1, IEC/EN 60947-3, UL 60947-4-1, CE, RCM and CCC. In fact, the IMO SI solar isolator has been tested by some of the most rigorous examiners and OEM manufacturers in the world, passing with flying colours every single time.

As ever, the SI range has a guaranteed arc suppression time of 3mS, in built arc cooling chambers, operator independent switching mechanism and Safe-Lock handle, making it one of the safest DC isolators available, no matter who uses it or how slowly they operate it.

**Why take a risk on safety? Insist on TRUE DC, contact us for a quotation and see why the IMO SI TRUE DC Isolator is the sensible choice for the PV installer.**

*Keep Solar Safe*



# SI Solar Isolators

## TRUE DC Isolators for PV Systems



- Market-leading design
- 2, 4, 6 & 8 pole versions available
- Max. rated current 85A@1000VDC (acc. to DC21B/DC-PV1 for SI55)
- Range of mounting options
- Guaranteed arc suppression (3ms typical)
- Operator independent switching mechanism
- Knife-edge contacts



### Innovators in TRUE DC isolation

Since its launch, the SI range of TRUE DC isolators has set the benchmark safety standard for disconnection and isolation of the DC panel load in solar applications world-wide. Prior to the introduction of the SI series, AC modified isolators in multi-pole linked form were commonly used with all the performance and safety issues that such devices presented.

The SI TRUE DC range was specifically developed to meet the needs of the solar industry with full operator independent switching mechanism, a guaranteed 5ms maximum arc suppression time and long-life knife edge contacts. Arc chambers built-in to the unit keep the device cool under repeated operation and the full range of mounting options provide a solution for almost every application.

Adopted as the standard by many of the largest solar equipment designers and installers around the world, the SI Series continues to set the benchmark in solar safety.

### Additional Resources

There is only so much you can illustrate in printed form, so we have included a QR code which will take you directly to the Featured Spotlight for TRUE DC isolators on the IMO website. Here you will be able to watch a couple of videos about solar safety and recommendations from the Institution of Engineering & Technology in conjunction with the BRE National Solar Centre, about raising the bar for quality in the solar PV industry.



# Ordering Variations

## Lever Handle Models

|  |   |   |  |
|--|---|---|--|
| Panel Mount (4-screw)<br>64 x 64 Escutcheon Plate<br>Lever Handle, IP66, NEMA 3R | Single Hole Mount (22.5mm) 48 x 48<br>Escutcheon Plate Lever Handle, IP66,<br>NEMA 4X | Base Mount (door coupling)<br>64 x 64 Escutcheon Plate<br>Lever Handle, IP66, NEMA 4X | Modular Switch<br>Lever Handle,<br>IP40, Open Type |
|  |   |   |  |
| <b>SI**PM64*</b>   | <b>SI**SHM*</b>   | <b>SI**BMD64*</b>   | <b>SI**DB*</b>                                     |

## Lever Handle Models with Lockable OFF

|   |  |  |   |
|---|--|--|---|
| Panel Mount (4-screw)<br>64 x 64 Escutcheon Plate Lockable<br>Lever Handle, IP66, NEMA 3R | Single Hole Mount (22.5mm)<br>48 x 48 Escutcheon Plate Lockable<br>Lever Handle, IP66, NEMA 4X | Base Mount (door coupling)<br>64 x 64 Escutcheon Plate Lockable<br>Lever Handle, IP66, NEMA 4X | Modular Switch<br>Lockable Lever Handle,<br>IP40, Open Type |
|   |  |  |   |
| <b>SI**PML64*</b>   | <b>SI**SHML*</b>   | <b>SI**BMDCL64*</b>  | <b>SI**DBL*</b>   |

## Rotary Handle Models with Lockable OFF

|   |  |  |
|---|--|--|
| Panel Mount (4-screw)<br>64 x 64 Lockable Rotary Handle,<br>IP66, NEMA 3R | Base Mount (door coupling)<br>64 x 64 Lockable Rotary Handle,<br>IP66, NEMA 4X | Enclosed Version<br>Lockable Rotary Handle,<br>IP67, NEMA 4X |
|   |  |  |
| <b>SI**PM64R*</b>   | <b>SI**BMD64R*</b>   | <b>SI**PEL64R*</b>   |

**NOTE:**

For description of each mounting mechanism please refer to pages 27 - 30.  
IP ratings are for front panel and enclosed.

## Part Number Configuration

|   |   |                      |  |  |  |               |  |          |        |           |                         |          |        |           |   |           |  |           |   |          |        |           |                         |          |        |           |                         |
|---|---|----------------------|--|--|--|---------------|--|----------|--------|-----------|-------------------------|----------|--------|-----------|---|-----------|--|-----------|---|----------|--------|-----------|-------------------------|----------|--------|-----------|-------------------------|
| <b>SI</b>   |   | <b>16</b>            |  | <b>- PM64R</b>   |  | <b>- 2</b>    |  |          |        |           |                         |          |        |           |   |           |  |           |   |          |        |           |                         |          |        |           |                         |
| <b>Series</b>   |   | <b>Switch Rating</b> |  | <b>Number of Poles (see Switching Configurations on p.5)</b>   |  |               |  |          |        |           |                         |          |        |           |   |           |  |           |   |          |        |           |                         |          |        |           |                         |
| SI DC Solar Isolator  |   | SI                   |  | <table border="1"> <tr><td><b>2</b></td><td>2-Pole</td></tr> <tr><td><b>2H</b></td><td>2-Pole 4 Parallel Poles</td></tr> <tr><td><b>4</b></td><td>4-Pole</td></tr> <tr><td><b>4S</b></td><td>2-Pole 4 Poles in Series (Input Top, Output bottom)</td></tr> <tr><td><b>4T</b></td><td>2-Pole 4 Poles in Series (Input &amp; Output bottom)</td></tr> <tr><td><b>4B</b></td><td>2-Pole 4 Poles in Series (Input &amp; Output top)</td></tr> <tr><td><b>6</b></td><td>6-Pole</td></tr> <tr><td><b>3H</b></td><td>2-Pole 6 Parallel Poles</td></tr> <tr><td><b>8</b></td><td>8-Pole</td></tr> <tr><td><b>4H</b></td><td>2-Pole 8 Parallel Poles</td></tr> </table> |  |               |  | <b>2</b> | 2-Pole | <b>2H</b> | 2-Pole 4 Parallel Poles | <b>4</b> | 4-Pole | <b>4S</b> | 2-Pole 4 Poles in Series (Input Top, Output bottom) | <b>4T</b> | 2-Pole 4 Poles in Series (Input & Output bottom) | <b>4B</b> | 2-Pole 4 Poles in Series (Input & Output top) | <b>6</b> | 6-Pole | <b>3H</b> | 2-Pole 6 Parallel Poles | <b>8</b> | 8-Pole | <b>4H</b> | 2-Pole 8 Parallel Poles |
| <b>2</b>  | 2-Pole  |                      |  |  |  |               |  |          |        |           |                         |          |        |           |   |           |  |           |   |          |        |           |                         |          |        |           |                         |
| <b>2H</b>   | 2-Pole 4 Parallel Poles                             |                      |  |  |  |               |  |          |        |           |                         |          |        |           |   |           |  |           |   |          |        |           |                         |          |        |           |                         |
| <b>4</b>  | 4-Pole  |                      |  |  |  |               |  |          |        |           |                         |          |        |           |   |           |  |           |   |          |        |           |                         |          |        |           |                         |
| <b>4S</b>   | 2-Pole 4 Poles in Series (Input Top, Output bottom) |                      |  |  |  |               |  |          |        |           |                         |          |        |           |   |           |  |           |   |          |        |           |                         |          |        |           |                         |
| <b>4T</b>   | 2-Pole 4 Poles in Series (Input & Output bottom)    |                      |  |  |  |               |  |          |        |           |                         |          |        |           |   |           |  |           |   |          |        |           |                         |          |        |           |                         |
| <b>4B</b>   | 2-Pole 4 Poles in Series (Input & Output top)       |                      |  |  |  |               |  |          |        |           |                         |          |        |           |   |           |  |           |   |          |        |           |                         |          |        |           |                         |
| <b>6</b>  | 6-Pole  |                      |  |  |  |               |  |          |        |           |                         |          |        |           |   |           |  |           |   |          |        |           |                         |          |        |           |                         |
| <b>3H</b>   | 2-Pole 6 Parallel Poles                             |                      |  |  |  |               |  |          |        |           |                         |          |        |           |   |           |  |           |   |          |        |           |                         |          |        |           |                         |
| <b>8</b>  | 8-Pole  |                      |  |  |  |               |  |          |        |           |                         |          |        |           |   |           |  |           |   |          |        |           |                         |          |        |           |                         |
| <b>4H</b>   | 2-Pole 8 Parallel Poles                             |                      |  |  |  |               |  |          |        |           |                         |          |        |           |   |           |  |           |   |          |        |           |                         |          |        |           |                         |
| <b>Mounting Type</b>  |   |                      |  |  |  |               |  |          |        |           |                         |          |        |           |   |           |  |           |   |          |        |           |                         |          |        |           |                         |
| Panel Mount (4-screw), 64 x 64 Escutcheon Plate, Lever Handle               |   |                      |  | <b>PM64</b>  |  |               |  |          |        |           |                         |          |        |           |   |           |  |           |   |          |        |           |                         |          |        |           |                         |
| Panel Mount (4-screw), 64 x 64 Escutcheon Plate, Lockable Lever Handle      |   |                      |  | <b>PML64</b>   |  |               |  |          |        |           |                         |          |        |           |   |           |  |           |   |          |        |           |                         |          |        |           |                         |
| Panel Mount (4-screw), 64 x 64 Lockable Rotary Handle                       |   |                      |  | <b>PM64R</b>   |  |               |  |          |        |           |                         |          |        |           |   |           |  |           |   |          |        |           |                         |          |        |           |                         |
| Single Hole (22.5mm) Mount, 48 x 48 Escutcheon Plate, Lever Handle          |   |                      |  | <b>SHM</b>   |  |               |  |          |        |           |                         |          |        |           |   |           |  |           |   |          |        |           |                         |          |        |           |                         |
| Single Hole (22.5mm) Mount, 48 x 48 Escutcheon Plate, Lockable Lever Handle |   |                      |  | <b>SHML</b>  |  |               |  |          |        |           |                         |          |        |           |   |           |  |           |   |          |        |           |                         |          |        |           |                         |
| Base Mount (DIN Rail), 64 x 64 Escutcheon Plate, Lever Handle               |   |                      |  | <b>BMD64</b>   |  |               |  |          |        |           |                         |          |        |           |   |           |  |           |   |          |        |           |                         |          |        |           |                         |
| Base Mount (DIN Rail), 64 x 64 Escutcheon Plate, Lockable Lever Handle      |   |                      |  | <b>BMDCL64</b>   |  |               |  |          |        |           |                         |          |        |           |   |           |  |           |   |          |        |           |                         |          |        |           |                         |
|   |   |                      |  | Base Mount (DIN Rail), 64 x 64 Lockable Rotary Handle  |  | <b>BMD64R</b> |  |          |        |           |                         |          |        |           |   |           |  |           |   |          |        |           |                         |          |        |           |                         |
|   |   |                      |  | Modular Switch, Lever Handle   |  | <b>DB</b>     |  |          |        |           |                         |          |        |           |   |           |  |           |   |          |        |           |                         |          |        |           |                         |
|   |   |                      |  | Modular Switch, Lockable Lever Handle  |  | <b>DBL</b>    |  |          |        |           |                         |          |        |           |   |           |  |           |   |          |        |           |                         |          |        |           |                         |
|   |   |                      |  | Enclosed Version, Lockable Rotary Handle   |  | <b>PEL64R</b> |  |          |        |           |                         |          |        |           |   |           |  |           |   |          |        |           |                         |          |        |           |                         |

# Switching Configurations

| Type                         | 2-pole | 2-pole<br>4 parallel poles | 4-pole | 4 poles in series<br>Input on top Output<br>bottom | 4 poles in series<br>Input and Output<br>bottom | 4 poles in series<br>Input and Output on top |
|------------------------------|--------|----------------------------|--------|--|---|--|
| SI16                         | 2      | 2H                         | 4      | 4S   | 4T  | 4B   |
| SI25                         | 2      | 2H                         | 4      | 4S   | 4T  | 4B   |
| SI32                         | 2      | 2H                         | 4      | 4S   | 4T  | 4B   |
| SI38                         | 2      | 2H                         | 4      | 4S   | 4T  | 4B   |
| SI40                         | 2      | 2H                         | 4      | 4S   | 4T  | 4B   |
| SI55                         | 2      | 2H                         | 4      | 4S   | 4T  | 4B   |
| SI65                         | 2      | 2H                         | 4      | 4S   | 4T  | 4B   |
| Contact<br>Wiring<br>Diagram |        |                            |        |  |   |  |
| Switching<br>Example         |        |                            |        |  |   |  |

| Type                          | 6-pole | 2-pole<br>6 parallel poles | 8-pole | 2-pole<br>8 parallel poles |
|-------------------------------|--------|----------------------------|--------|----------------------------|
| SI16                          | 6      | 3H                         | 8      | 4H                         |
| SI25                          | 6      | 3H                         | 8      | 4H                         |
| SI32                          | 6      | 3H                         | 8      | 4H                         |
| SI38                          | 6      | 3H                         | 8      | 4H                         |
| SI40                          | 6      | 3H                         | 8      | 4H                         |
| SI55                          | 6      | 3H                         | 8      | 4H                         |
| SI65                          | 6      | 3H                         | 8      | 4H                         |
| Contacts<br>Wiring<br>Diagram |        |                            |        |                            |
| Switching<br>example          |        |                            |        |                            |

## Insulated Jumper for series and parallel switching of contacts

| Type         | SI16 | SI25                       | SI32 | SI38         | SI40                       | SI55         | SI65 |  |
|--------------|------|----------------------------|------|--------------|----------------------------|--------------|------|--|
| 4T / 4B / 4S |      | 2x SIV-B1-1N               |      | 2x SIV-B1-2N |                            | 2x SIV-B2-2N |      |  |
| 2H           |      | 4x SIV-B1-1N               |      |              |                            | 4x SIV-B2-1N |      |  |
| 4H           |      | 8x SIV-B1-1N, 2x SIV-B1-2N |      |              | 8x SIV-B2-1N, 2x SIV-B2-2N |              |      |  |

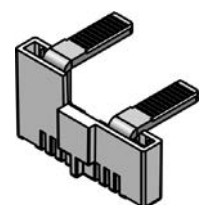



SIV-B1-1N

**WARNING:** Verify that all connections (including bridging link connections) are suitable for the rated current, prepared to ensure only conductive parts are clamped and tightened to the manufacturer's required torque before energisation.

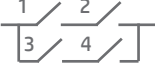
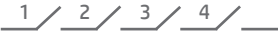
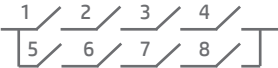
## Technical Data for DC according to IEC 60947-3



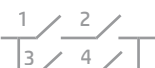



| Type  |             | DC-PV1 |      |      |      |      |       |       |       | DC22B |      |       |       |
|---|-------------|--------|------|------|------|------|-------|-------|-------|-------|------|-------|-------|
|   |             | 500V   | 600V | 700V | 800V | 900V | 1000V | 1200V | 1500V | 500V  | 600V | 800V  | 1000V |
| 2 poles in series<br>2<br>               | <b>SI16</b> | 16A    | 16A  | 16A  | 16A  | 16A  | 10A   | 7A    | 3A    | 7A    | 5.5A | 2A    | 1A    |
|   | <b>SI25</b> | 25A    | 25A  | 25A  | 20A  | 17A  | 11.5A | 8.5A  | 5A    | 8A    | 6A   | 2.5A  | 1.5A  |
|   | <b>SI32</b> | 32A    | 32A  | 32A  | 23A  | 20A  | 13A   | 10A   | 6A    | 9A    | 6.5A | 3A    | 2A    |
|   | <b>SI38</b> | 45A    | 45A  | 36A  | 30A  | 25A  | 20A   | 10A   | 6A    |       |      |       |       |
|   | <b>SI40</b> | 48A    | 48A  | 37A  | 35A  | 31A  | 29A   | 11A   | 7.5A  |       |      |       |       |
|   | <b>SI55</b> | 55A    | 55A  | 55A  | 55A  | 43A  | 36A   | 17A   | 10A   |       |      |       |       |
|   | <b>SI65</b> | 75A    | 75A  | 75A  | 65A  | 55A  | 40A   | 17A   | 10A   |       |      |       |       |
| 2 poles in series + 2 parallel<br>2H<br> | <b>SI16</b> | 29A    | 29A  | 22A  | 17A  | 16A  | 10A   | 7A    | 3A    |       |      |       |       |
|   | <b>SI25</b> | 45A    | 45A  | 27A  | 20A  | 17A  | 11.5A | 8.5A  | 5A    |       |      |       |       |
|   | <b>SI32</b> | 58A    | 55A  | 32A  | 23A  | 20A  | 13A   | 10A   | 6A    |       |      |       |       |
|   | <b>SI38</b> | 65A    | 58A  | 36A  | 30A  | 25A  | 20A   | 10A   | 6A    |       |      |       |       |
|   | <b>SI40</b> | 72A    | 68A  | 49A  | 42A  | 31A  | 29A   | 11A   | 8A    |       |      |       |       |
|   | <b>SI55</b> | 85A    | 85A  | 77A  | 63A  | 43A  | 36A   | 17A   | 10A   |       |      |       |       |
|   | <b>SI65</b> | 85A    | 85A  | 80A  | 65A  | 55A  | 40A   | 17A   | 10A   |       |      |       |       |
| 4 poles in series<br>4S, 4B, 4T<br>      | <b>SI16</b> | 16A    | 16A  | 16A  | 16A  | 16A  | 16A   | 16A   | 16A   | 16A   | 16A  | 11.5A | 8A    |
|   | <b>SI25</b> | 25A    | 25A  | 25A  | 25A  | 25A  | 25A   | 25A   | 25A   | 25A   | 25A  | 12A   | 9A    |
|   | <b>SI32</b> | 32A    | 32A  | 32A  | 32A  | 32A  | 32A   | 32A   | 32A   | 32A   | 32A  | 12.5A | 10A   |
|   | <b>SI38</b> | 45A    | 45A  | 45A  | 45A  | 45A  | 38A   | 32A   | 32A   |       |      |       |       |
|   | <b>SI40</b> | 48A    | 48A  | 48A  | 48A  | 48A  | 40A   | 40A   | 40A   |       |      |       |       |
|   | <b>SI55</b> | 55A    | 55A  | 55A  | 55A  | 55A  | 55A   | 55A   | 55A   |       |      |       |       |
|   | <b>SI65</b> | 75A    | 75A  | 75A  | 75A  | 75A  | 75A   | 65A   | 65A   |       |      |       |       |
| 4 poles in series + 2 parallel<br>4H<br> | <b>SI16</b> | 29A    | 29A  | 29A  | 29A  | 29A  | 29A   | 29A   | 20A   |       |      |       |       |
|   | <b>SI25</b> | 45A    | 45A  | 45A  | 45A  | 45A  | 45A   | 33A   | 26A   |       |      |       |       |
|   | <b>SI32</b> | 58A    | 58A  | 58A  | 58A  | 58A  | 58A   | 50A   | 32A   |       |      |       |       |
|   | <b>SI38</b> | 65A    | 65A  | 65A  | 65A  | 65A  | 65A   | 50A   | 32A   |       |      |       |       |
|   | <b>SI40</b> | 72A    | 72A  | 72A  | 72A  | 72A  | 72A   | 56A   | 42A   |       |      |       |       |
|   | <b>SI55</b> | 85A    | 85A  | 85A  | 85A  | 85A  | 85A   | 65A   | 55A   |       |      |       |       |
|   | <b>SI65</b> | 85A    | 85A  | 85A  | 85A  | 85A  | 85A   | 65A   | 55A   |       |      |       |       |

## Technical Data for DC according to UL508i

| Type  |             | UL508i |      |      |      |      |      |       |
|---|-------------|--------|------|------|------|------|------|-------|
|   |             | 350V   | 500V | 600V | 700V | 800V | 900V | 1000V |
| 2 poles in series<br>2<br>               | <b>SI16</b> | 16A    | 16A  | 16A  |      |      |      |       |
|   | <b>SI25</b> | 25A    | 25A  | 25A  |      |      |      |       |
|   | <b>SI32</b> | 32A    | 32A  | 32A  |      |      |      |       |
|   | <b>SI38</b> | 45A    | 45A  | 45A  |      |      |      |       |
|   | <b>SI40</b> | 48A    | 48A  | 48A  | 32A  | 26A  | 20A  | 16A   |
|   | <b>SI55</b> | 55A    | 55A  | 55A  | 46A  | 37A  | 28A  | 20A   |
|   | <b>SI65</b> | 65A    | 65A  | 65A  | 50A  | 40A  | 32A  | 25A   |
| 2 poles in series + 2 parallel<br>2H<br> | <b>SI16</b> | 29A    | 29A  | 21A  |      |      |      |       |
|   | <b>SI25</b> | 45A    | 41A  | 30A  |      |      |      |       |
|   | <b>SI32</b> | 58A    | 43A  | 33A  |      |      |      |       |
|   | <b>SI38</b> | 58A    | 45A  | 36A  |      |      |      |       |
|   | <b>SI40</b> | 72A    | 53A  | 42A  | 35A  | 30A  | 26A  | 22A   |
|   | <b>SI55</b> | 85A    | 66A  | 55A  | 47A  | 40A  | 32A  | 25A   |
|   | <b>SI65</b> | 85A    | 73A  | 65A  | 50A  | 40A  | 32A  | 23A   |
| 4 poles in series<br>4S, 4H, 4T<br>      | <b>SI16</b> | 16A    | 16A  | 16A  |      |      |      |       |
|   | <b>SI25</b> | 25A    | 25A  | 25A  |      |      |      |       |
|   | <b>SI32</b> | 32A    | 32A  | 32A  |      |      |      |       |
|   | <b>SI38</b> | 45A    | 45A  | 36A  |      |      |      |       |
|   | <b>SI40</b> | 48A    | 48A  | 40A  | 40A  | 40A  | 40A  | 40A   |
|   | <b>SI55</b> | 55A    | 55A  | 55A  | 55A  | 55A  | 55A  | 55A   |
|   | <b>SI65</b> | 65A    | 65A  | 65A  | 65A  | 65A  | 65A  | 65A   |
| 4 poles in series + 2 parallel<br>4H<br> | <b>SI16</b> | 29A    | 29A  | 29A  |      |      |      |       |
|   | <b>SI25</b> | 45A    | 45A  | 45A  |      |      |      |       |
|   | <b>SI32</b> | 58A    | 58A  | 50A  |      |      |      |       |
|   | <b>SI38</b> | 58A    | 58A  | 50A  |      |      |      |       |
|   | <b>SI40</b> | 80A    | 71A  | 65A  | 58A  | 51A  | 45A  | 42A   |
|   | <b>SI55</b> | 85A    | 85A  | 85A  | 76A  | 71A  | 67A  | 64A   |
|   | <b>SI65</b> | 85A    | 85A  | 85A  | 85A  | 76A  | 73A  | 70A   |

# Technical Data

Data according to IEC 60947-3, VDE 0660, GB14048.3

| Main Contacts   |  | Type            | SI16  | SI25 | SI32 | SI38 | SI40 | SI55 |    |     |    |     |     |     |    |
|---|--|-----------------|---|------|------|------|------|------|----|-----|----|-----|-----|-----|----|
| Rated thermal current $I_{the}$   |  | A               | 16  | 25   | 32   | 45   | 48   | 55   |    |     |    |     |     |     |    |
| Rated insulation voltage $U_i^{1)}$   |  | V               | 1000  | 1000 | 1000 | 1000 | 1500 | 1500 |    |     |    |     |     |     |    |
| Rated insulation voltage $U_i^{2)}$   |  | V               | 1500  | 1500 | 1500 | 1500 | 1500 | 1500 |    |     |    |     |     |     |    |
| Distance of contacts (per pole)   |  | mm              | 8   | 8    | 8    | 8    | 8    | 8    |    |     |    |     |     |     |    |
| <b>Rated operational current <math>I_e</math></b>   |  |                 |   |      |      |      |      |      |    |     |    |     |     |     |    |
| <b>DC21A &amp; DC21B</b>  | 1 pole<br>1<br>                                     | 300V            | A   | 16   | 23   | 27   | 27   | 40   | 55 |     |    |     |     |     |    |
|   |  | 400V            | A   | 12   | 14   | 14   | 22   | 16   | 25 | 16  | 25 | 30  | 33  | 40  | 44 |
|   |  | 500V            | A   | 9    | 10   | 11   | 17   | 13   | 20 | 13  | 20 | 19  | 24  | 25  | 32 |
|   |  | 600V            | A   | 6    | 7    | 8    | 12   | 10   | 15 | 10  | 15 | 15  | 19  | 20  | 25 |
|   |  | 700V            | A   | 4.5  | 5    | 6    |      | 7.5  |    | 7.5 |    | 10  | 12  | 15  | 18 |
|   |  | 800V            | A   | 3    |      | 4    |      | 5    |    | 5   |    | 8   | 10  | 10  | 13 |
|   |  | 900V            | A   | 2.5  | 3    | 3    |      | 4    |    | 4   |    | 6   | 8   | 8   | 10 |
|   |  | 1000V           | A   | 1.5  | 2    | 2    |      | 2.5  | 3  | 2.5 | 3  | 4   | 5   | 6   | 8  |
|   |  | <b>DC21B</b>    | 2 poles in series<br>2<br> | 500V | A    | 16   | 25   | 32   |    | 45  | 48 |     | 55  |     |    |
|   |  |                 |   | 600V | A    | 16   | 25   | 32   |    | 45  | 48 |     | 55  |     |    |
| 700V  | A  |                 |   | 16   | 23   | 25   | 27   | 32   |    | 36  | 35 | 37  | 55  |     |    |
| 800V  | A  |                 |   | 16   | 16   | 20   |      | 23   |    | 30  | 35 |     | 45  | 55  |    |
| 900V  | A  |                 |   | 13   | 16   | 16   | 17   |      | 20 |     | 25 | 25  | 31  | 35  | 43 |
| 1000V   | A  |                 |   | 9    | 10   | 11   | 11.5 | 13   |    | 20  | 25 | 29  |     | 36  |    |
| 1200V   | A  |                 |   | 6    | 7    | 8    | 8.5  | 10   |    |     | 10 | 11  | 15  | 17  |    |
| 1500V   | A  |                 |   | 3    |      | 4    | 5    | 5    | 6  |     | 6  | 6   | 7.5 | 7.5 | 10 |
| 2 poles in series<br>+ 2 poles parallel<br>2H<br> | 500V   |                 |   | A    | 29   | 45   | 58   |      |    | 65  | 72 |     | 85  |     |    |
|   | 600V   |                 |   | A    | 29   | 45   | 50   | 55   |    |     | 64 | 68  | 80  | 85  |    |
|   | 700V   |                 |   | A    | 16   | 22   | 23   | 27   | 27 | 32  |    | 35  | 49  | 55  | 77 |
|   | 800V   |                 |   | A    | 16   | 17   | 20   |      | 23 |     | 30 | 35  | 42  | 45  | 63 |
|   | 900V   |                 |   | A    | 13   | 16   | 16   | 17   |    | 20  |    | 25  | 31  | 35  | 43 |
|   | 1000V  |                 |   | A    | 9    | 10   | 11   | 11.5 | 13 |     | 20 | 23  | 29  | 25  | 36 |
|   | 1200V  |                 |   | A    | 6    | 7    | 8    | 8.5  | 10 |     |    | 10  | 11  | 15  | 17 |
|   | 1500V  | A               | 3   |      | 4    | 5    | 5    | 6    |    | 6   | 6  | 7.5 | 7.5 | 10  |    |
|   | 3 poles in series<br>+ 2 poles parallel<br>3H<br> | 500V            | A   | 29   | 45   | 58   |      |      |    | 72  |    | 85  |     |     |    |
|   |  | 600V            | A   | 29   | 45   | 50   | 58   |      |    | 72  |    | 85  |     |     |    |
| 700V  |  | A               | 29  | 38   | 43   | 45   | 55   |      | 72 |     | 85 |     |     |     |    |
| 800V  |  | A               | 29  | 38   | 40   |      | 51   |      | 68 |     | 85 |     |     |     |    |
| 900V  |  | A               | 29  |      | 38   |      | 47   |      | 62 |     | 78 |     |     |     |    |
| 1000V   |  | A               | 29  |      | 38   |      | 45   |      | 58 |     | 70 |     |     |     |    |
| 1200V   |  | A               | 12  |      | 14   | 25   | 16   | 28   |    |     |    |     |     |     |    |
| 1500V   |  | A               | 9   |      | 11   | 14   | 13   | 20   |    |     |    |     |     |     |    |
| 4 poles in series<br>4S, 4B, 4T<br>              |  | 500V            | A   | 16   | 25   | 32   |      |      | 45 | 48  |    | 55  |     |     |    |
|   |  | 600V            | A   | 16   | 25   | 32   |      |      | 45 | 48  |    | 55  |     |     |    |
|   | 700V   | A               | 16  | 25   | 32   |      |      |      | 40 |     | 55 |     |     |     |    |
|   | 800V   | A               | 16  | 25   | 32   |      |      |      | 40 |     | 55 |     |     |     |    |
|   | 900V   | A               | 16  | 25   | 32   |      |      |      | 40 |     | 55 |     |     |     |    |
|   | 1000V  | A               | 16  | 25   | 32   |      |      | 38   | 40 |     | 55 |     |     |     |    |
|   | 1200V  | A               | 16  | 25   | 32   |      |      |      | 40 |     | 55 |     |     |     |    |
|   | 1500V  | A               | 16  | 20   | 25   | 23   | 32   |      | 32 | 30  | 40 | 40  | 55  |     |    |
|   | 4 poles in series<br>+ 2 poles parallel<br>4H<br> | 500V            | A   | 29   | 45   | 58   |      |      | 65 | 72  |    | 85  |     |     |    |
|   |  | 600V            | A   | 29   | 45   | 58   |      |      |    | 72  |    | 85  |     |     |    |
| 700V  |  | A               | 29  | 45   |      | 58   |      |      | 72 |     | 85 |     |     |     |    |
| 800V  |  | A               | 29  | 45   |      | 58   |      |      | 72 |     | 85 |     |     |     |    |
| 900V  |  | A               | 29  | 45   |      | 58   |      |      | 72 |     | 85 |     |     |     |    |
| 1000V   |  | A               | 29  |      | 45   |      | 58   |      | 65 |     | 72 |     | 85  |     |    |
| 1200V   |  | A               | 29  |      | 45   | 50   |      |      | 50 |     | 56 |     | 65  |     |    |
| 1500V   |  | A               | 16  |      | 20   | 26   | 23   | 32   |    | 32  |    | 42  |     | 55  |    |
| <b>Rated operational current <math>I_e</math></b>   |  |                 |   |      |      |      |      |      |    |     |    |     |     |     |    |
| AC21B   |  | 2, 4            | $U_e$ max. 440V   | A    | 16   | 25   | 32   | 45   | 48 | 55  |    |     |     |     |    |
|   | 2H   | $U_e$ max. 440V | A   | 29   | 45   | 58   | 72   | 85   |    |     |    |     |     |     |    |





1) Suitable at overvoltage category I to III, pollution degree 3 (standard-industry):  $U_{imp} = 8kV$ .

2) Suitable at overvoltage category I to III, pollution degree 2 (min.IP55):  $U_{imp} = 8kV$ .





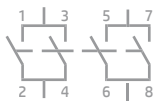
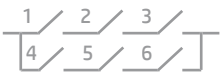

# Technical Data continued

Data according to IEC 60947-3, VDE 0660, GB14048.3

| Main Contacts  | Type   | SI16 | SI25 | SI32 | SI38 | SI40 | SI55 | SI65 |    |    |
|--|--|------|------|------|------|------|------|------|----|----|
| <b>Rated operational current I<sub>n</sub></b><br>1 pole<br>1<br> | 300V   | A    | 16   | 23   | 27   | 27   | 40   | 55   | 65 |    |
|  | 400V   | A    | 14   | 22   | 25   | 25   | 33   | 44   | 50 |    |
|  | 500V   | A    | 10   | 17   | 20   | 20   | 24   | 32   | 40 |    |
|  | 600V   | A    | 7    | 12   | 15   | 15   | 19   | 25   | 30 |    |
|  | 700V   | A    | 5    | 6    | 7.5  | 7.5  | 12   | 18   | 21 |    |
|  | 800V   | A    | 3    | 4    | 5    | 5    | 10   | 13   | 15 |    |
|  | 900V   | A    | 3    | 3    | 4    | 4    | 8    | 10   | 10 |    |
|  | 1000V  | A    | 2    | 2    | 3    | 3    | 5    | 8    | 8  |    |
|  | 2 poles in series<br>2<br>                          | 500V | A    | 16   | 25   | 32   | 45   | 48   | 55 | 75 |
|  |  | 600V | A    | 16   | 25   | 32   | 45   | 48   | 55 | 75 |
| 700V   |  | A    | 16   | 25   | 32   | 36   | 37   | 55   | 75 |    |
| 800V   |  | A    | 16   | 20   | 23   | 30   | 35   | 55   | 65 |    |
| 900V   |  | A    | 16   | 17   | 20   | 25   | 31   | 43   | 55 |    |
| 1000V  |  | A    | 10   | 11.5 | 13   | 20   | 29   | 36   | 40 |    |
| 1100V  |  | A    | 8    | 10   | 11.5 | -    | 19   | 25   | -  |    |
| 1200V  |  | A    | 7    | 8.5  | 10   | 10   | 11   | 17   | 17 |    |
| 1300V  |  | A    | 6    | 7    | 8    | -    | 10   | 14   | -  |    |
| 1400V  |  | A    | 5    | 6    | 7    | -    | 9    | 12   | -  |    |
| 1500V  |  | A    | 3    | 5    | 6    | 6    | 8    | 10   | 10 |    |
| 2 poles in series<br>+ 2 poles parallel<br>2H<br>                 |  | 500V | A    | 29   | 45   | 58   | 65   | 72   | 85 | 85 |
|  |  | 600V | A    | 29   | 45   | 55   | 58   | 68   | 85 | 85 |
|  |  | 700V | A    | 22   | 27   | 32   | 36   | 49   | 77 | 80 |
|  |  | 800V | A    | 17   | 20   | 23   | 30   | 42   | 63 | 65 |
|  | 900V   | A    | 16   | 17   | 20   | 25   | 31   | 43   | 55 |    |
|  | 1000V  | A    | 10   | 11.5 | 13   | 20   | 29   | 36   | 40 |    |
|  | 1100V  | A    | 8    | 10   | 11.5 | -    | 19   | 25   | -  |    |
|  | 1200V  | A    | 7    | 8.5  | 10   | 10   | 11   | 17   | 17 |    |
|  | 1300V  | A    | 6    | 7    | 8    | -    | 10   | 14   | -  |    |
|  | 1400V  | A    | 5    | 6    | 7    | -    | 9    | 12   | -  |    |
|  | 1500V  | A    | 3    | 5    | 6    | 6    | 8    | 10   | 10 |    |
|  | 3 poles in series<br>+ 2 poles parallel<br>3H<br> | 500V | A    | 29   | 45   | 58   | -    | 72   | 85 | -  |
|  |  | 600V | A    | 29   | 45   | 58   | -    | 72   | 85 | -  |
|  |  | 700V | A    | 29   | 43   | 55   | -    | 72   | 85 | -  |
|  |  | 800V | A    | 29   | 40   | 51   | -    | 68   | 85 | -  |
| 900V   |  | A    | 29   | 38   | 47   | -    | 62   | 78   | -  |    |
| 1000V  |  | A    | 29   | 38   | 45   | -    | 58   | 70   | -  |    |
| 1100V  |  | A    | 19   | 27   | 37   | -    | -    | -    | -  |    |
| 1200V  |  | A    | 17   | 25   | 28   | -    | -    | -    | -  |    |
| 1300V  |  | A    | 15   | 21   | 25   | -    | -    | -    | -  |    |
| 1400V  |  | A    | 12   | 18   | 22   | -    | -    | -    | -  |    |
| 1500V  |  | A    | 10   | 14   | 20   | -    | -    | -    | -  |    |
| 4 poles in series<br>4S, 4B, 4T<br>                             |  | 500V | A    | 16   | 25   | 32   | 45   | 48   | 55 | 75 |
|  |  | 600V | A    | 16   | 25   | 32   | 45   | 48   | 55 | 75 |
|  |  | 700V | A    | 16   | 25   | 32   | 45   | 48   | 55 | 75 |
|  |  | 800V | A    | 16   | 25   | 32   | 45   | 48   | 55 | 75 |
|  | 900V   | A    | 16   | 25   | 32   | 45   | 48   | 55   | 75 |    |
|  | 1000V  | A    | 16   | 25   | 32   | 38   | 40   | 55   | 75 |    |
|  | 1100V  | A    | 16   | 25   | 32   | -    | 40   | 55   | 65 |    |
|  | 1200V  | A    | 16   | 25   | 32   | 32   | 40   | 55   | 65 |    |
|  | 1300V  | A    | 16   | 25   | 32   | -    | 40   | 55   | 65 |    |
|  | 1400V  | A    | 16   | 25   | 32   | -    | 40   | 55   | 65 |    |
|  | 1500V  | A    | 16   | 25   | 32   | 32   | 40   | 55   | 65 |    |
|  | 4 poles in series<br>+ 2 poles parallel<br>4H<br> | 500V | A    | 29   | 45   | 58   | 65   | 72   | 85 | 85 |
|  |  | 600V | A    | 29   | 45   | 58   | 65   | 72   | 85 | 85 |
|  |  | 700V | A    | 29   | 45   | 58   | 65   | 72   | 85 | 85 |
|  |  | 800V | A    | 29   | 45   | 58   | 65   | 72   | 85 | 85 |
| 900V   |  | A    | 29   | 45   | 58   | 65   | 72   | 85   | 85 |    |
| 1000V  |  | A    | 29   | 45   | 58   | 65   | 72   | 85   | 85 |    |
| 1100V  |  | A    | 29   | 45   | 54   | -    | 60   | 68   | -  |    |
| 1200V  |  | A    | 29   | 45   | 50   | 50   | 56   | 65   | 65 |    |
| 1300V  |  | A    | 26   | 39   | 44   | -    | 50   | 61   | -  |    |
| 1400V  |  | A    | 23   | 33   | 38   | -    | 46   | -    | -  |    |
| 1500V  |  | A    | 20   | 26   | 32   | 32   | 42   | 55   | 55 |    |

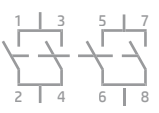
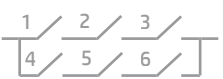
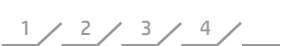

# Technical Data continued

Data according to IEC 60947-3, VDE 0660, GB14048.3

| Main Contacts   |   | Type  | SI16  | SI25 | SI32 | SI38 | SI40 | SI55 | SI65 |    |    |    |
|---|---|---|---|------|------|------|------|------|------|----|----|----|
| <b>Rated operational current I<sub>n</sub></b><br>1 pole<br>1 |    | 300V  | A   | 16   | 23   | 27   | 27   | 40   | 55   | -  |    |    |
|   |   | 400V  | A   | 14   | 18   | 20   | 20   | 30   | 40   | -  |    |    |
|   |   | 500V  | A   | 10   | 12   | 14   | 14   | 19   | 25   | -  |    |    |
|   |   | 600V  | A   | 5    | 6    | 8    | 8    | 10   | 13   | -  |    |    |
|   |   | 700V  | A   | 1.5  | 2    | 3    | 3    | 7    | 10   | -  |    |    |
|   |   | 800V  | A   | 1.5  | 2    | 3    | 3    | 6    | 8    | -  |    |    |
|   |   | 900V  | A   | 1    | 1.5  | 2    | 2    | 5    | 6    | -  |    |    |
|   |   | 1000V   | A   | 1    | 1.5  | 2    | 2    | 3    | 4    | -  |    |    |
|   |   | <b>DC-PV2</b><br>2 poles in series<br>2       |    | 500V | A    | 16   | 25   | 32   | 38   | 40 | 55 | 75 |
|   |   |   |   | 600V | A    | 14   | 21   | 27   | 31   | 40 | 55 | 75 |
| 700V  | A   |   |   | 13   | 19   | 22   | 25   | 35   | 55   | 65 |    |    |
| 800V  | A   |   |   | 12   | 15   | 17   | 19   | 33   | 49   | 52 |    |    |
| 900V  | A   |   |   | 8    | 10   | 12   | 14   | 25   | 35   | 38 |    |    |
| 1000V   | A   |   |   | 4    | 5    | 6    | 7    | 16   | 20   | 20 |    |    |
| 1100V   | A   |   |   | 3    | 4    | 5    | -    | 11   | 15   | -  |    |    |
| 1200V   | A   |   |   | 2    | 3    | 4    | 4    | 8    | 12   | 12 |    |    |
| 1300V   | A   |   |   | 1.5  | 2    | 3    | -    | 7    | 10   | -  |    |    |
| 1400V   | A   |   |   | 1    | 2    | 3    | -    | 7    | 9    | -  |    |    |
| 1500V   | A   |   |   | 1    | 1.5  | 2    | 2    | 6    | 8    | 8  |    |    |
| 2 poles in series<br>+ 2 poles parallel<br>2H                 |    |   |   | 500V | A    | 25   | 39   | 50   | 58   | 72 | 85 | 85 |
|   |   |   |   | 600V | A    | 20   | 32   | 35   | 38   | 60 | 75 | 75 |
|   |   |   |   | 700V | A    | 13   | 19   | 22   | 25   | 38 | 60 | 65 |
|   |   |   |   | 800V | A    | 12   | 15   | 17   | 19   | 33 | 49 | 52 |
|   |   | 900V  | A   | 8    | 10   | 12   | 14   | 25   | 35   | 38 |    |    |
|   |   | 1000V   | A   | 4    | 5    | 6    | 7    | 16   | 20   | 20 |    |    |
|   |   | 1100V   | A   | 3    | 4    | 5    | -    | 11   | 15   | -  |    |    |
|   |   | 1200V   | A   | 2    | 3    | 4    | 4    | 8    | 12   | 12 |    |    |
|   |   | 1300V   | A   | 1.5  | 2    | 3    | -    | 7    | 10   | -  |    |    |
|   |   | 1400V   | A   | 1    | 2    | 3    | -    | 7    | 9    | -  |    |    |
|   |   | 1500V   | A   | 1    | 1.5  | 2    | 2    | 6    | 8    | 8  |    |    |
|   |   | 3 poles in series<br>+ 2 poles parallel<br>3H |  | 500V | A    | 24   | 45   | 58   | 65   | 72 | 85 | -  |
|   |   |   |   | 600V | A    | 22   | 34   | 44   | 48   | 72 | -  | -  |
|   |   |   |   | 700V | A    | 20   | 28   | 34   | 35   | 62 | 69 | -  |
|   |   |   |   | 800V | A    | 18   | 24   | 29   | 31   | 53 | 61 | -  |
| 900V  | A   |   |   | 16   | 20   | 24   | 24   | 55   | -    | -  |    |    |
| 1000V   | A   |   |   | 14   | 18   | 20   | 20   | 35   | 50   | -  |    |    |
| 1100V   | A   |   |   | -    | -    | -    | -    | -    | -    | -  |    |    |
| 1200V   | A   |   |   | 11   | 13   | 15   | 15   | -    | -    | -  |    |    |
| 1300V   | A   |   |   | -    | -    | -    | -    | -    | -    | -  |    |    |
| 1400V   | A   |   |   | -    | -    | -    | -    | -    | -    | -  |    |    |
| 1500V   | A   |   |   | 4    | 6    | 8    | 8    | -    | -    | -  |    |    |
| 4 poles in series<br>4S, 4B, 4T                               |  |   |   | 500V | A    | 16   | 25   | 32   | 45   | 48 | 55 | 75 |
|   |   |   |   | 600V | A    | 16   | 25   | 32   | 45   | 48 | 55 | 75 |
|   |   |   |   | 700V | A    | 16   | 25   | 32   | 45   | 48 | 55 | 75 |
|   |   |   |   | 800V | A    | 16   | 25   | 32   | 38   | 40 | 55 | 75 |
|   |   | 900V  | A   | 16   | 25   | 32   | 38   | 40   | 55   | 65 |    |    |
|   |   | 1000V   | A   | 16   | 25   | 32   | 38   | 40   | 55   | 65 |    |    |
|   |   | 1100V   | A   | 15   | 25   | 32   | -    | -    | 55   | -  |    |    |
|   |   | 1200V   | A   | 13.5 | 21   | 27   | 27   | 40   | 55   | 55 |    |    |
|   |   | 1300V   | A   | 12   | 19   | 24   | -    | -    | 50   | -  |    |    |
|   |   | 1400V   | A   | 10.5 | 16   | 21   | -    | -    | 45   | -  |    |    |
|   |   | 1500V   | A   | 9    | 14   | 18   | 18   | 30   | 40   | 40 |    |    |
|   |   | 4 poles in series<br>+ 2 poles parallel<br>4H |  | 500V | A    | 29   | 45   | 58   | 65   | 72 | 85 | -  |
|   |   |   |   | 600V | A    | 29   | 45   | 58   | 65   | 72 | 85 | -  |
|   |   |   |   | 700V | A    | 25   | 40   | 53   | 65   | 72 | 80 | -  |
|   |   |   |   | 800V | A    | 21   | 35   | 45   | 60   | 67 | 75 | -  |
| 900V  | A   |   |   | 18   | 30   | 37   | 55   | 59   | 70   | -  |    |    |
| 1000V   | A   |   |   | 16   | 25   | 32   | 50   | 52   | 64   | -  |    |    |
| 1100V   | A   |   |   | -    | -    | -    | -    | 44   | 59   | -  |    |    |
| 1200V   | A   |   |   | 13.5 | 21   | 27   | 27   | 40   | 55   | -  |    |    |
| 1300V   | A   |   |   | -    | -    | -    | -    | 36   | 50   | -  |    |    |
| 1400V   | A   |   |   | -    | -    | -    | -    | 33   | 45   | -  |    |    |
| 1500V   | A   |   |   | 9    | 14   | 18   | 18   | 30   | 40   | -  |    |    |

# Technical Data continued







Data according to IEC 60947-3, VDE 0660, GB14048.3

| Main Contacts  |  | Type              | SI16  | SI25        | SI32      | SI38       | SI40   | SI55/SI65  |            |
|--|--|-------------------|---|-------------|-----------|------------|--|------------|------------|
| <b>DC22B</b>   | 1 pole<br>1<br>                     | 500V              | A   | 1           | 1.25      | 1.5        | x  | x          | 2.5        |
|  |  | 600V              | A   | 0.5         | 0.75      | 1          | x  | x          | 2          |
|  |  | 800V              | A   | 0.3         | 0.4       | 0.5        | x  | x          | 1.5        |
|  |  | 1000V             | A   | 0.15        | 0.2       | 0.25       | x  | x          | 1          |
|  |  | 1200V             | A   |             |           |            | x  | x          | x          |
|  |  | 1500V             | A   |             |           |            | x  | x          | x          |
|  | 2 poles in series<br>2<br>          | 500V              | A   | 7           | 8         | 9          | x  | x          | x          |
|  |  | 600V              | A   | 5.5         | 6         | 6.5        | x  | x          | x          |
|  |  | 800V              | A   | 2           | 2.5       | 3          | x  | x          | x          |
|  |  | 1000V             | A   | 1           | 1.5       | 2          | x  | x          | x          |
|  |  | 1200V             | A   |             |           |            | x  | x          | x          |
|  |  | 1500V             | A   |             |           |            | x  | x          | x          |
|  | 4 poles in series<br>4S, 4B, 4T<br> | 500V              | A   | 16          | 25        | 32         | x  | x          | x          |
|  |  | 600V              | A   | 16          | 25        | 27.5       | x  | x          | x          |
|  |  | 800V              | A   | 11.5        | 12        | 12.5       | x  | x          | x          |
|  |  | 1000V             | A   | 8           | 9         | 10         | x  | x          | x          |
|  |  | 1200V             | A   |             |           |            | x  | x          | x          |
|  |  | 1500V             | A   |             |           |            | x  | x          | x          |
| <b>Rated conditional short-circuit current</b>         |  | kA <sub>eff</sub> | 5   | 5           | 5         | 5          | 10   | 10         |            |
| Max. fuse size   |  | gL (gG)           | A   | 40          | 63        | 80         | 80   | 125        | 160        |
| Mechanical Life  |  | x10 <sup>3</sup>  |   | 10          | 10        | 10         | 10   | 10         | 10         |
| Rated short-time withstand current (1s)                | I <sub>cw</sub>  | 2, 4, 6, 8        | A   | 800         | 900       | 1000       | 1000   | 2, 4: 1200 | 2, 4: 1400 |
|  |  | 2H, 3H, 4H        | A   | 1300        | 1500      | 1700       | 1700   | 2H: 2000   | 2H: 2400   |
| Short circuit making capacity                          | I <sub>cw</sub>  | 2, 4, 6, 8        | A   | 800         | 900       | 1000       | 1000   | 2, 4: 1200 | 2, 4: 1400 |
|  |  | 2H, 3H, 4H        | A   | 1300        | 1500      | 1700       | 1700   | 2H: 2000   | 2H: 2400   |
| <b>Maximum cable cross sections</b> (including jumper) |  |                   | SIV-B1-1                                      |             |           |            | SIV-B2-1                                       |            |            |
| solid or stranded                                      | mm <sup>2</sup>  |                   | 4 - 16  | 4 - 16      | 4 - 16    | 4 - 16     | 2.5 - 25                                       | 2.5 - 25   |            |
| flexible   | mm <sup>2</sup>  |                   | 4 - 10  | 4 - 10      | 4 - 10    | 4 - 10     | 4 - 16   | 4 - 16     |            |
| flexible (+ multicore cable end)                       | mm <sup>2</sup>  |                   | 4 - 10  | 4 - 10      | 4 - 10    | 4 - 10     | 2.5 - 16                                       | 2.5 - 16   |            |
| Size of terminal screw                                 |  |                   | M4 Pz2  | M4 Pz2      | M4 Pz2    | M4 Pz2     | M5 Pz2   | M5 Pz2     |            |
| Tightening torque                                      | Nm   |                   | 1.7 - 1.8                                     | 1.7 - 1.8   | 1.7 - 1.8 | 1.7 - 1.8  | 2.5 - 2.8                                      | 2.5 - 2.8  |            |
| 2 cables per clamp without jumper                      |  |                   |   |             |           |            |  |            |            |
| solid or stranded                                      | mm <sup>2</sup>  |                   | 16+(1.5-2.5)/10+(1.5-6)/6+(1.5-10)/4+(1.5-10) |             |           |            | 16+(1.5-2.5)/10+(1.5-10)/6+(1.5-10)/4+(1.5-10) |            |            |
| flexible & flexible + multicore cable end              | mm <sup>2</sup>  |                   | 16+(1.5-2.5)/10+(1.5-4)/6+(1.5-6)             |             |           |            | 16+(1.5-6)/10+(1.5-10)/6+(1.5-16)/4+(1.5-16)   |            |            |
| stranded   | AWG  |                   | 8+(16-12)/10+(16-10)/12+(16-8)/14+(16-8)      |             |           |            | 3+(18-10)/4+(18-10)/6+(18-8)/8+(18-8)          |            |            |
| solid  | AWG  |                   | 10+(16-12)/12+(16-10)/14+(16-10)              |             |           |            | 10+(16-10)/12+(16-10)/14+(16-10)/14+(16-10)    |            |            |
| <b>Maximum ambient temperature</b>                     |  |                   |   |             |           |            |  |            |            |
| Operation  | All types except PEL64R  | °C                | -40 to +65                                    |             |           |            |  |            |            |
|  | PEL64R type  | °C                | -40 to +45                                    |             |           |            |  |            |            |
| Storage  |  | °C                | -50 to +90                                    |             |           |            |  |            |            |
| <b>Power loss per switch at I<sub>e max.</sub></b>     |  |                   | A   | A           | A         |            | A  | A          |            |
| 2  | (A) / W  | (16) / 1          | (25) / 2.3                                    | (32) / 3.7  |           | (40) / 4   | (55) / 7.5                                     |            |            |
| 4  | (A) / W  | (16) / 2          | (25) / 4.6                                    | (32) / 7.4  |           | (40) / 8   | (55) / 15                                      |            |            |
| 6  | (A) / W  | (16) / 3          | (25) / 6.9                                    | (32) / 11.1 |           | (40) / 12  | (55) / 22.5                                    |            |            |
| 8  | (A) / W  | (16) / 4          | (25) / 9.2                                    | (32) / 14.8 |           | (40) / 16  | (55) / 30                                      |            |            |
| 2H   | (A) / W  | (29) / 1.5        | (45) / 3.7                                    | (58) / 6    |           | (72) / 6.5 | (85) / 9                                       |            |            |
| 3H   | (A) / W  | (29) / 2.3        | (45) / 5.6                                    | (58) / 9    |           | (72) / 9.8 | (85) / 14                                      |            |            |
| 4H   | (A) / W  | (29) / 3          | (45) / 7.4                                    | (58) / 12   |           | (72) / 13  | (85) / 18                                      |            |            |
| Contact Resistance per pole                            |  | mΩ                | 1.75  | 1.75        | 1.75      | 1.75       | 1.25   | 1.25       |            |

x - In Test

# Technical Data continued

Data according to UL508i  File E362605, CCN: NMSJ and UL60947-1 & UL60947-4-1  File E146487, CCN: NRNT, NRNT7

| Main Contacts  |  | Type                             | SI16    | SI25    | SI32    | SI38    | SI40    | SI55    | SI65    |   |
|--|--|----------------------------------|---------|---------|---------|---------|---------|---------|---------|---|
| Ampere-Rating "General Use"  |  | DC                               |         |         |         |         |         |         |         |   |
| 1 pole<br>1<br>                                     | 350V   | A                                | 4       | 5       | 6       | 6       | 7.1     | 10      | 10      |   |
|  | 500V   | A                                | 4       | 5       | 6       | 6       | 5.7     | 7       | 7       |   |
|  | 600V   | A                                | 4       | 5       | 6       | 6       | 5       | 5.8     | 5.8     |   |
|  | 700V   | A                                |         |         |         |         | 3.9     | 5       | 5       |   |
|  | 800V   | A                                |         |         |         |         | 3.2     | 4.4     | 4.4     |   |
|  | 900V   | A                                |         |         |         |         | 2.5     | 3.5     | 3.5     |   |
|  | 1000V  | A                                |         |         |         |         | 1.5     | 2       | 2       |   |
| 2 poles in series<br>2<br>                          | 350V   | A                                | 16      | 25      | 32      | 45      | 48      | 55      | 65      |   |
|  | 500V   | A                                | 16      | 25      | 32      | 45      | 48      | 55      | 65      |   |
|  | 600V   | A                                | 16      | 25      | 32      | 36      | 40      | 55      | 65      |   |
|  | 700V   | A                                |         |         |         |         | 32      | 46      | 50      |   |
|  | 800V   | A                                |         |         |         |         | 26      | 37      | 40      |   |
|  | 900V   | A                                |         |         |         |         | 20      | 28      | 32      |   |
| 2 poles in series<br>+ 2 poles parallel<br>2H<br>   | 350V   | A                                | 29      | 45      | 58      | 58      | 72      | 85      | 85      |   |
|  | 500V   | A                                | 29      | 41      | 43      | 45      | 53      | 66      | 73      |   |
|  | 600V   | A                                | 21      | 30      | 33      | 36      | 42      | 55      | 65      |   |
|  | 700V   | A                                |         |         |         |         | 35      | 47      | 50      |   |
|  | 800V   | A                                |         |         |         |         | 30      | 40      | 40      |   |
|  | 900V   | A                                |         |         |         |         | 26      | 32      | 32      |   |
| 4 poles in series<br>4S, 4B, 4T<br>                 | 350V   | A                                | 16      | 25      | 32      | 45      | 48      | 55      | 65      |   |
|  | 500V   | A                                | 16      | 25      | 32      | 45      | 48      | 55      | 65      |   |
|  | 600V   | A                                | 16      | 25      | 32      | 36      | 40      | 55      | 65      |   |
|  | 700V   | A                                |         |         |         |         | 40      | 55      | 65      |   |
|  | 800V   | A                                |         |         |         |         | 40      | 55      | 65      |   |
|  | 900V   | A                                |         |         |         |         | 40      | 55      | 65      |   |
| 3 poles in series<br>+ 2 poles parallel<br>3H<br> | 350V   | A                                | 29      | 45      | 58      | 58      | 72      | 85      | 85      |   |
|  | 500V   | A                                | 29      | 41      | 50      | 50      | 56      | 80      | 85      |   |
|  | 600V   | A                                | 21      | 38      | 45      | 45      | 52      | 65      | 72      |   |
|  | 700V   | A                                |         |         |         |         | 46      | 58      | 66      |   |
|  | 800V   | A                                |         |         |         |         | 40      | 51      | 60      |   |
|  | 900V   | A                                |         |         |         |         | 36      | 45      | 54      |   |
| 4 poles in series<br>+ 2 poles parallel<br>4H<br> | 350V   | A                                | 29      | 45      | 58      | 58      | 80      | 85      | 85      |   |
|  | 500V   | A                                | 29      | 45      | 58      | 58      | 71      | 85      | 85      |   |
|  | 600V   | A                                | 29      | 45      | 50      | 50      | 65      | 85      | 85      |   |
|  | 700V   | A                                |         |         |         |         | 58      | 76      | 85      |   |
|  | 800V   | A                                |         |         |         |         | 51      | 71      | 76      |   |
|  | 900V   | A                                |         |         |         |         | 45      | 67      | 73      |   |
| AC Rating "General Use"  | 2 poles in series<br> | 600V                             | A       | 16      | 25      | 32      |         | 40      | 55      | - |
|  |  | 277V                             | A       |         |         | 50      |         | 72      | 85      | - |
| 3 poles parallel   |  | 3x480V                           | A       |         |         | 32      |         | 40      | 55      | - |
| Fuse size (RKS) Industrial Control Switch  |  |                                  |         |         |         |         |         |         |         |   |
| 5kA / 600V   |  | A                                | 40      | 60      | 80      | 80      | -       | -       | -       |   |
| 5kA / 1000V  |  | A                                |         |         |         |         | 160     | 160     | 160     |   |
| <b>Maximum cable cross sections</b>  |  | (including jumper SIV-B1-1/B2-1) |         |         |         |         |         |         |         |   |
| solid or stranded  |  | AWG                              | 12 - 10 | 12 - 10 | 12 - 10 | 12 - 10 | 16 - 10 | 16 - 10 | 16 - 10 |   |
| flexible   |  | AWG                              | 12 - 6  | 12 - 6  | 12 - 6  | 12 - 6  | 14 - 4  | 14 - 4  | 14 - 4  |   |
| flexible (+ multicore cable end)   |  | AWG                              | 12 - 6  | 12 - 6  | 12 - 6  | 12 - 6  |         |         |         |   |
| Size of terminal screw   |  |                                  | M4 Pz2  | M4 Pz2  | M4 Pz2  | M4 Pz2  | M5 Pz2  | M5 Pz2  | M5 Pz2  |   |
| Tightening torque  |  | lb.inch                          | 9 - 16  | 9 - 16  | 9 - 16  | 9 - 16  | 22 - 25 | 22 - 25 | 22 - 25 |   |

x - In Test

# Technical Data continued

Switch SI16 2 poles DC-PV1 Open Type

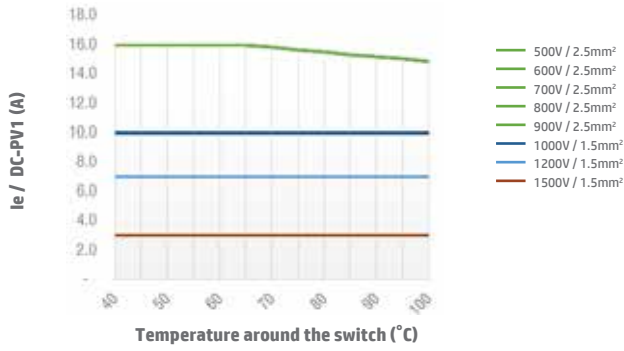

Switch SI16 2 poles DC-PV1 Enclosed Type

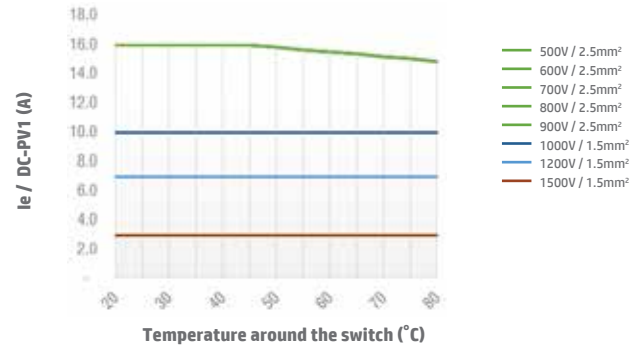

Switch SI16 2H DC-PV1 Open Type

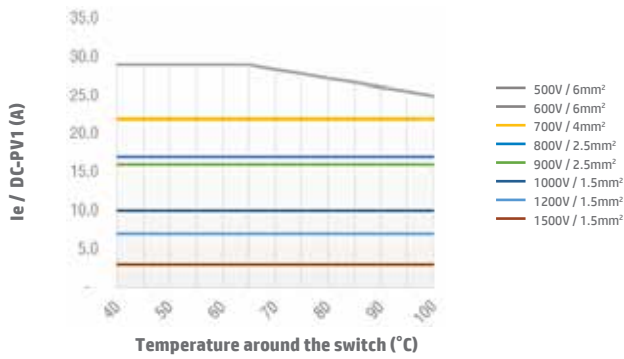

Switch SI16 2H DC-PV1 Enclosed Type

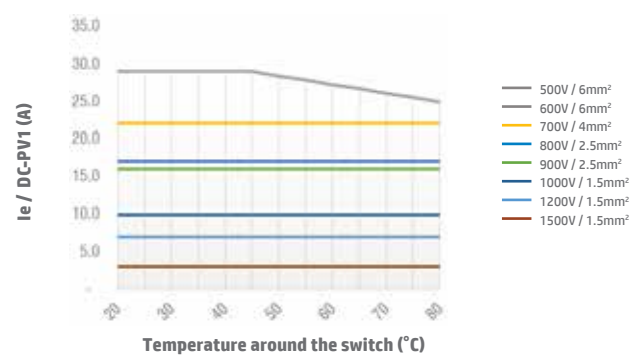

Switch SI16 4B/4S/4T DC-PV1 Open Type

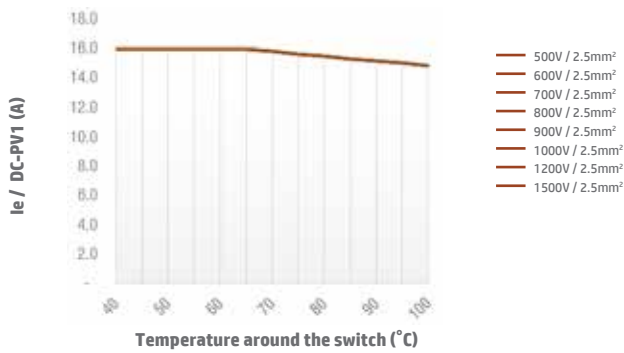

Switch SI16 4B/4S/4T DC-PV1 Enclosed Type

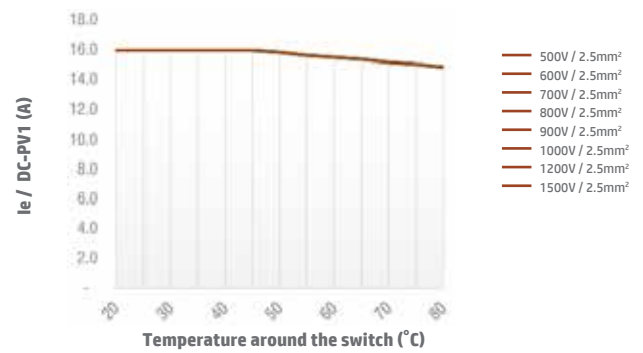

Switch SI16 4H DC-PV1 Open Type

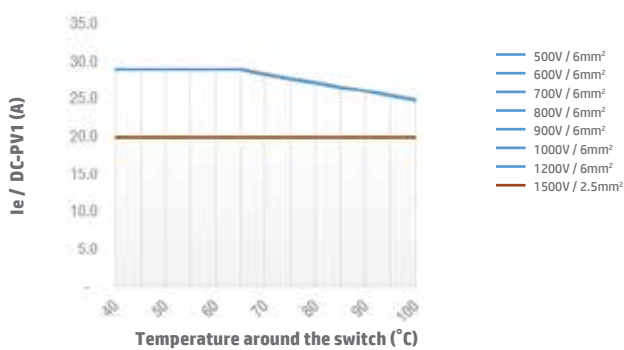

Switch SI16 4H DC-PV1 Enclosed Type

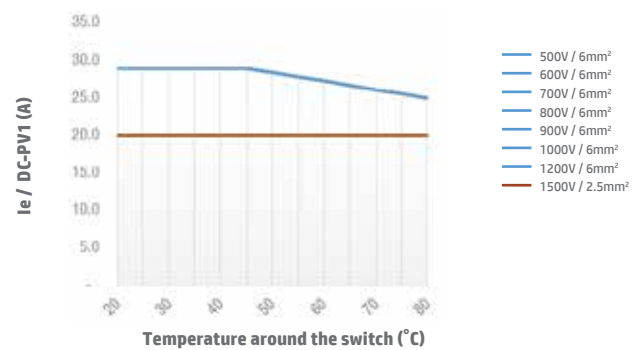

# Technical Data continued

Switch SI25 2 poles DC-PV1 Open Type

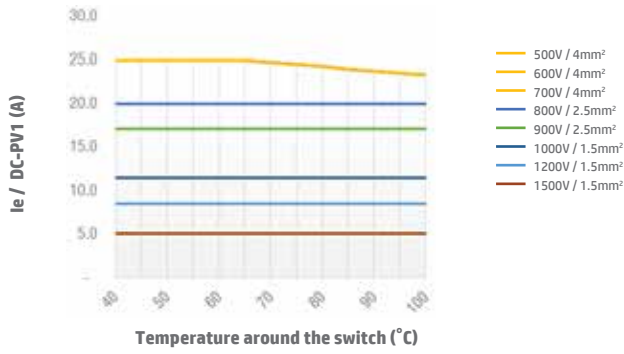

Switch SI25 2 poles DC-PV1 Enclosed Type

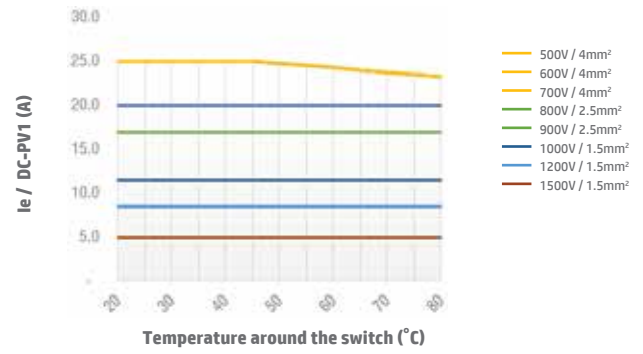

Switch SI25 2H DC-PV1 Open Type

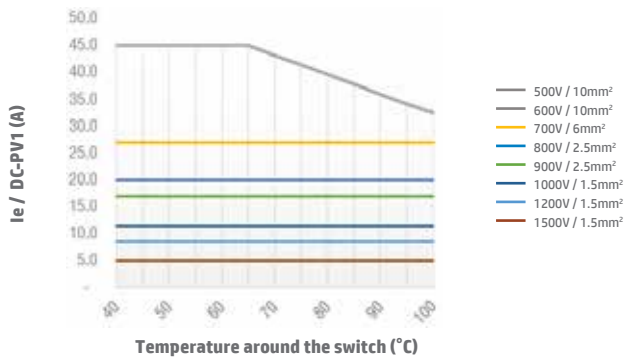

Switch SI25 2H DC-PV1 Enclosed Type

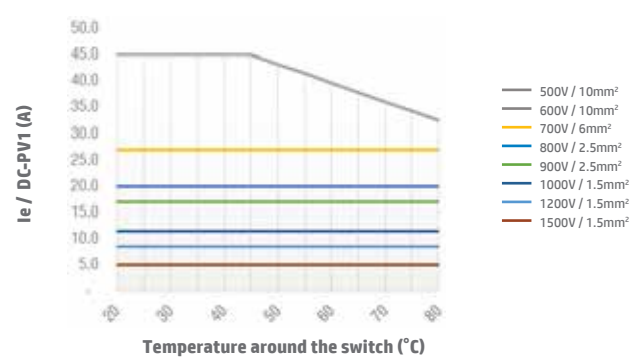

Switch SI25 4B/4S/4T DC-PV1 Open Type

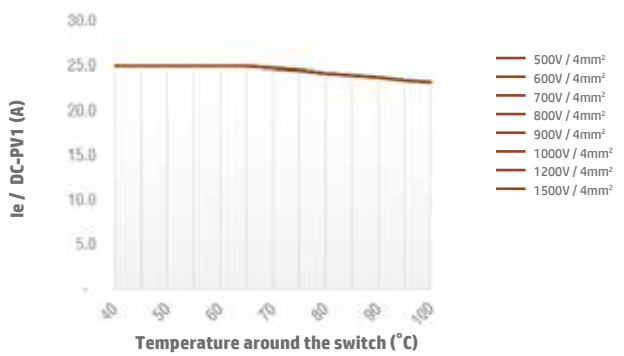

Switch SI25 4B/4S/4T DC-PV1 Enclosed Type

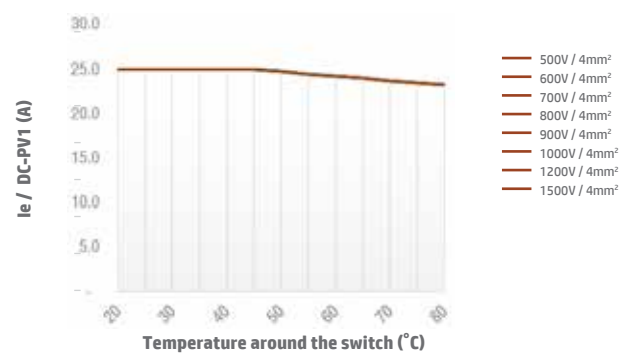

Switch SI25 4H DC-PV1 Open Type

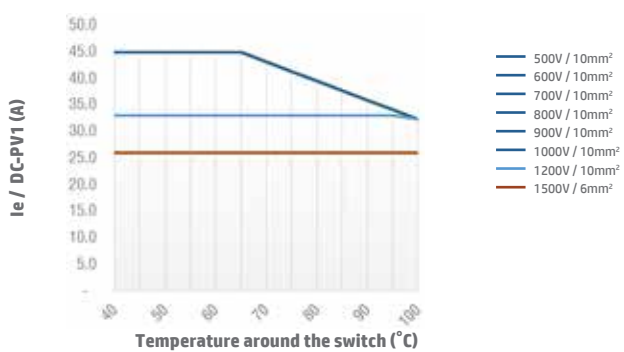

Switch SI25 4H DC-PV1 Enclosed Type

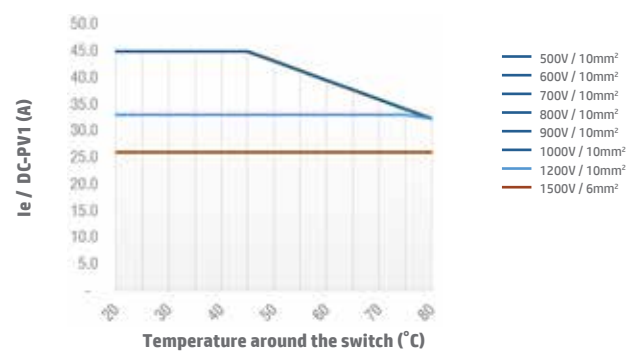

# Technical Data continued

Switch SI32 2 poles DC-PV1 Open Type

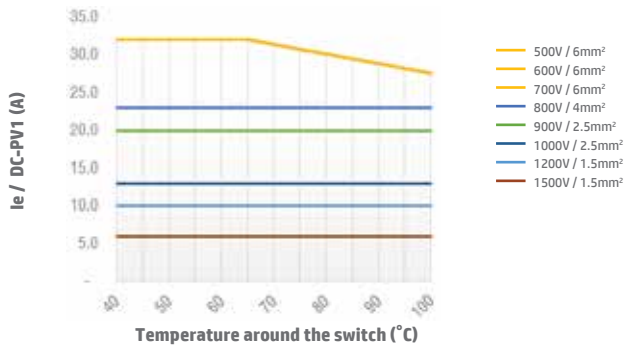

Switch SI32 2 poles DC-PV1 Enclosed Type

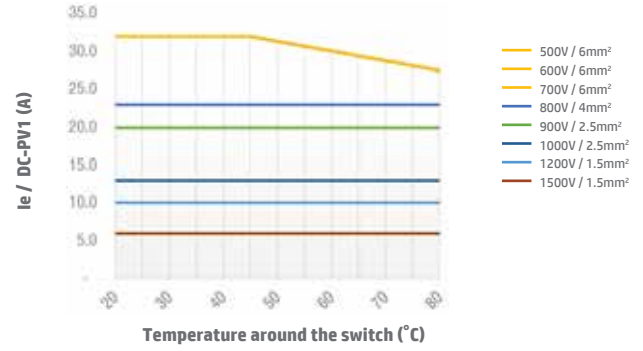

Switch SI32 2H DC-PV1 Open Type

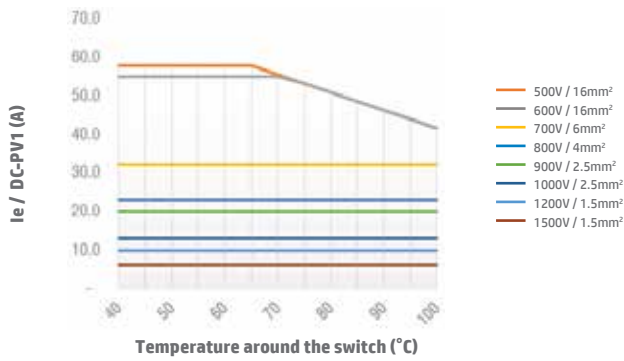

Switch SI32 2H DC-PV1 Enclosed Type

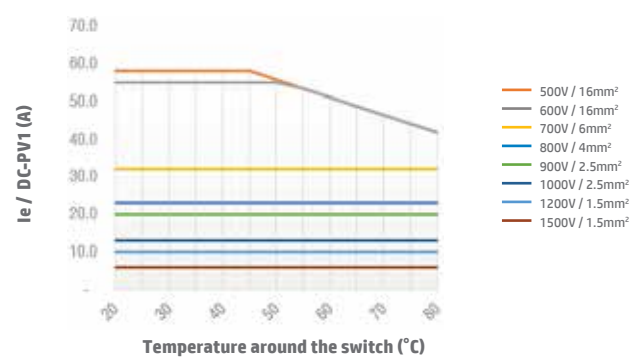

Switch SI32 4B/4S/4T DC-PV1 Open Type

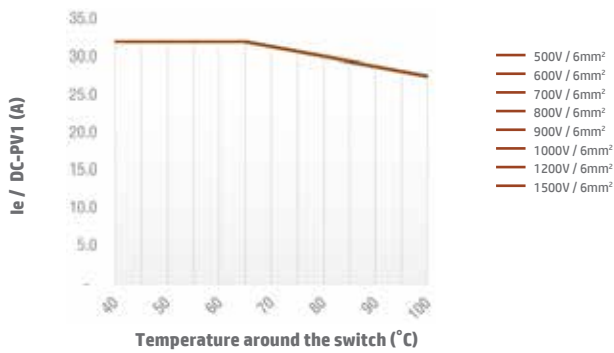

Switch SI32 4B/4S/4T DC-PV1 Enclosed Type

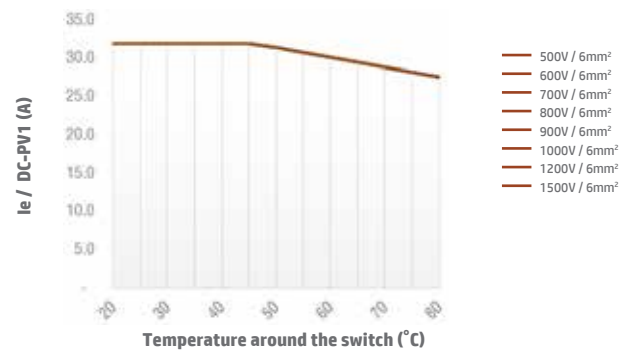

Switch SI32 4H DC-PV1 Open Type

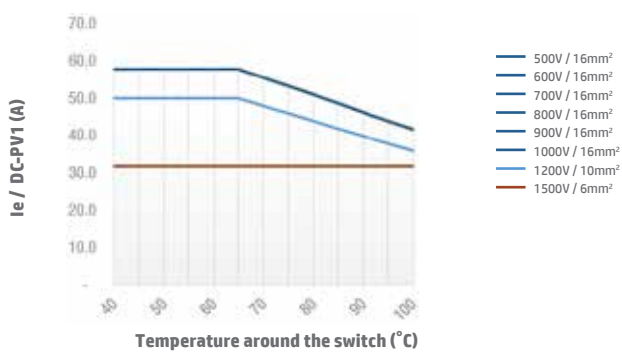

Switch SI32 4H DC-PV1 Enclosed Type

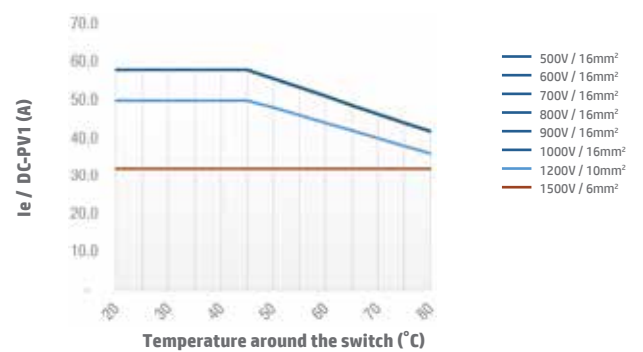

# Technical Data continued

Switch SI38 2 poles DC-PV1 Open Type

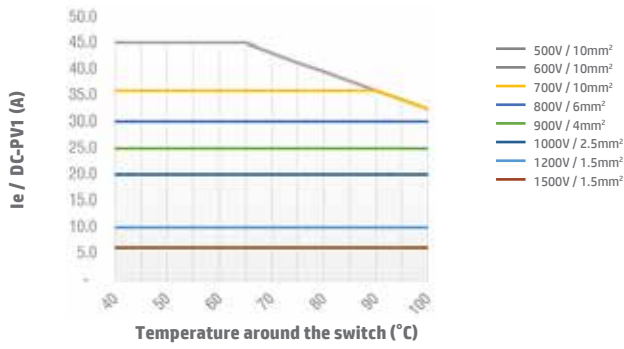

Switch SI38 2 poles DC-PV1 Enclosed Type

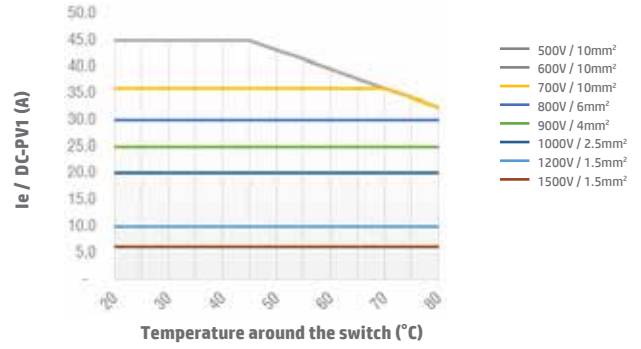

Switch SI38 2H DC-PV1 Open Type

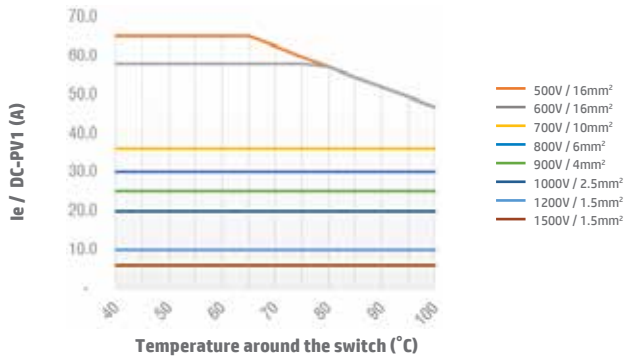

Switch SI38 2H DC-PV1 Enclosed Type

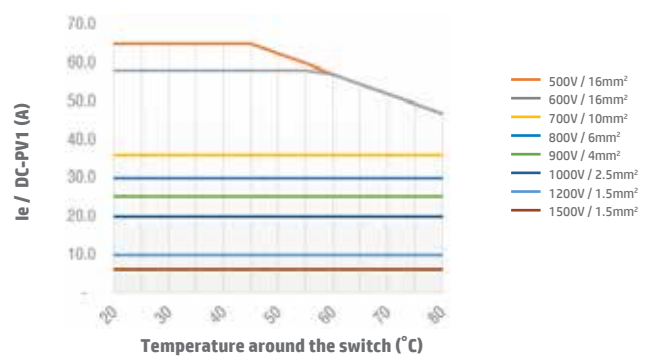

Switch SI38 4B/4S/4T DC-PV1 Open Type

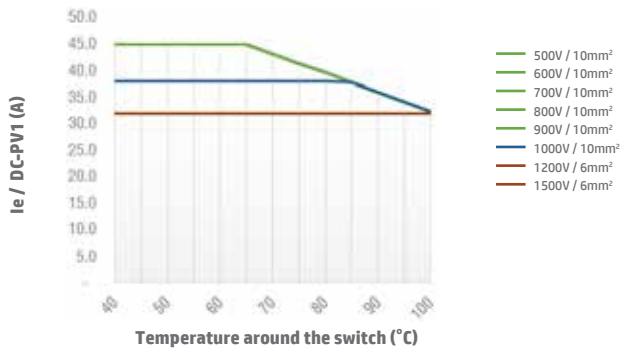

Switch SI38 4B/4S/4T DC-PV1 Enclosed Type

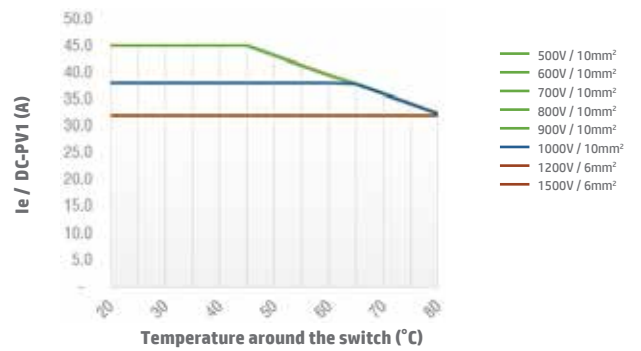

Switch SI38 4H DC-PV1 Open Type

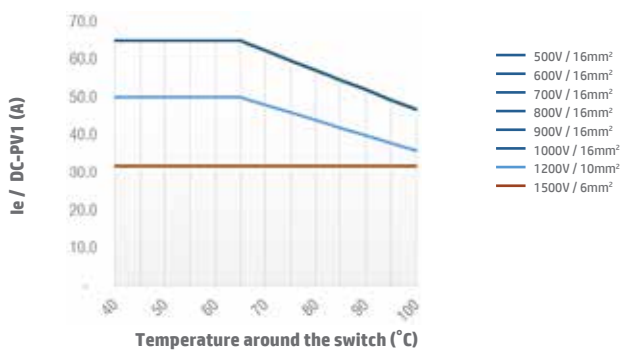

Switch SI38 4H DC-PV1 Enclosed Type

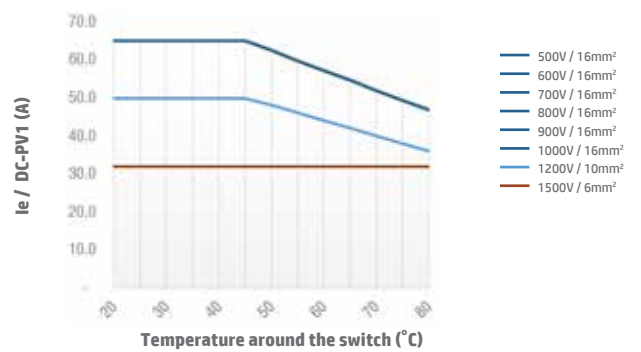



# Technical Data continued

Switch SI40 2 poles DC-PV1 Open Type

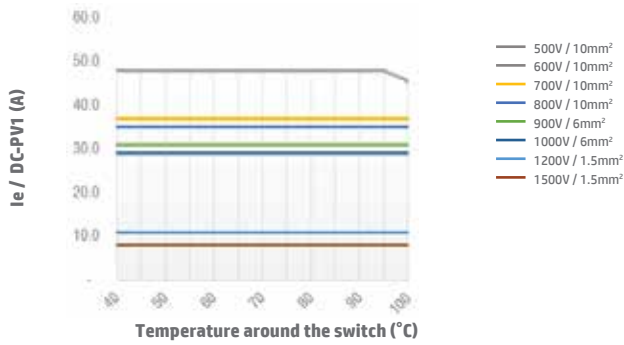

Switch SI40 2 poles DC-PV1 Enclosed Type

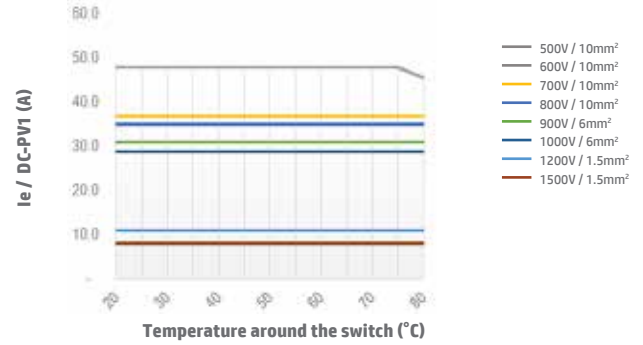

Switch SI40 2H DC-PV1 Open Type

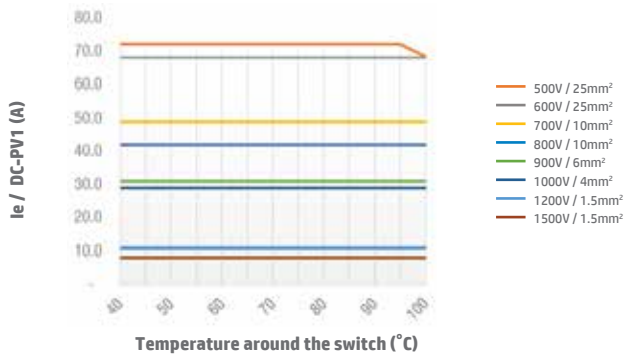

Switch SI40 2H DC-PV1 Enclosed Type

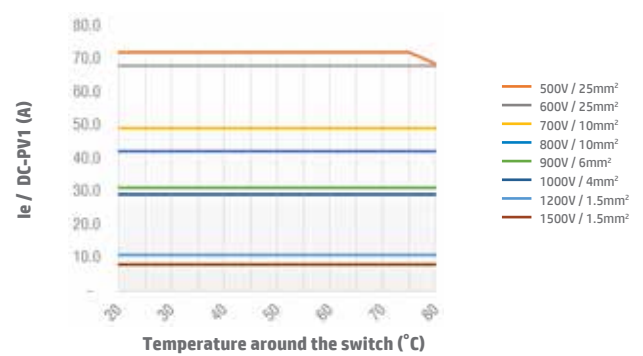

Switch SI40 4B/4S/4T DC-PV1 Open Type

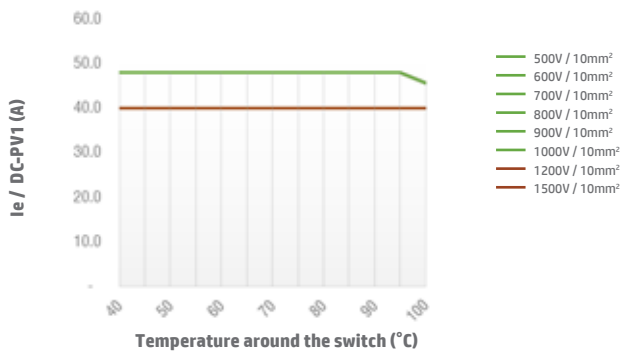

Switch SI40 4B/4S/4T DC-PV1 Enclosed Type

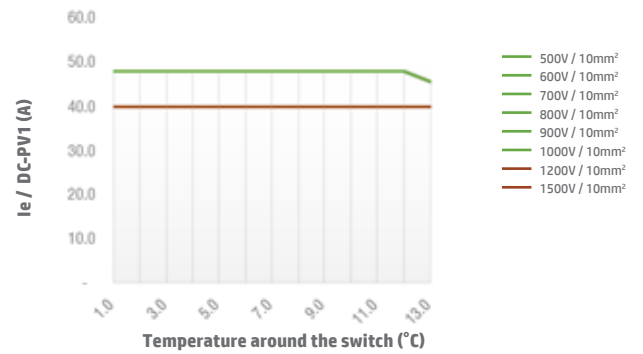

Switch SI40 4H DC-PV1 Open Type

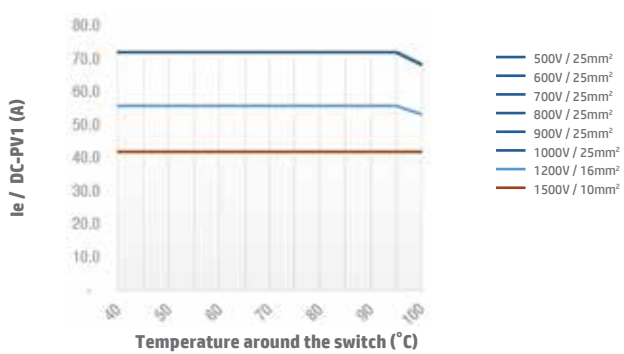

Switch SI40 4H DC-PV1 Enclosed Type

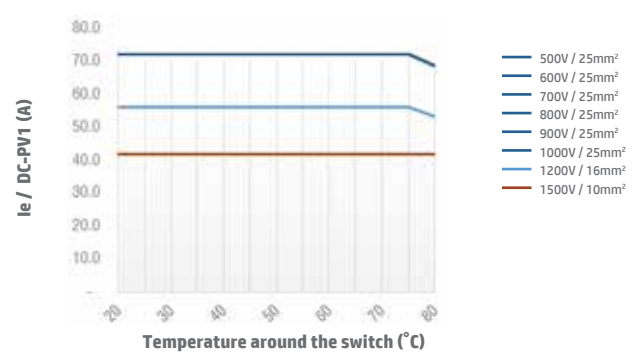

**Note:** For SI40 3H pole configuration, DC-PV1 derating graphs can be supplied upon request. Please contact IMO for more information.

# Technical Data continued

Switch SI55 2 poles DC-PV1 Open Type

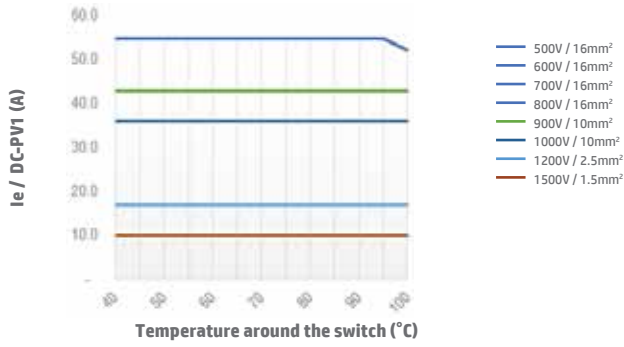

Switch SI55 2 poles DC-PV1 Enclosed Type

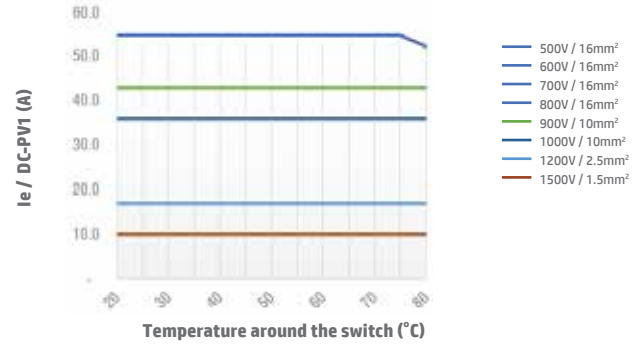

Switch SI55 2H DC-PV1 Open Type

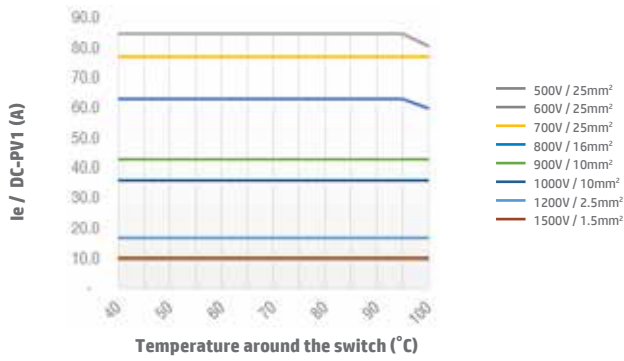

Switch SI55 2H DC-PV1 Enclosed Type

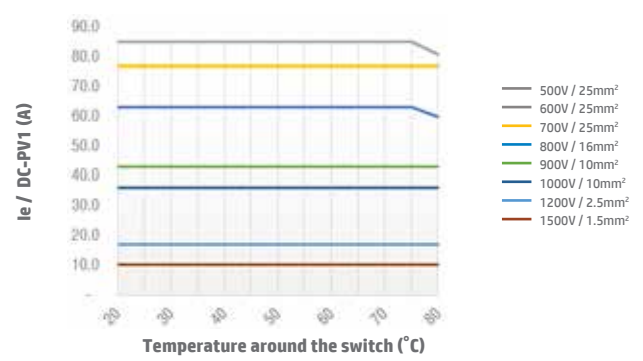

Switch SI55 4B/4S/4T DC-PV1 Open Type

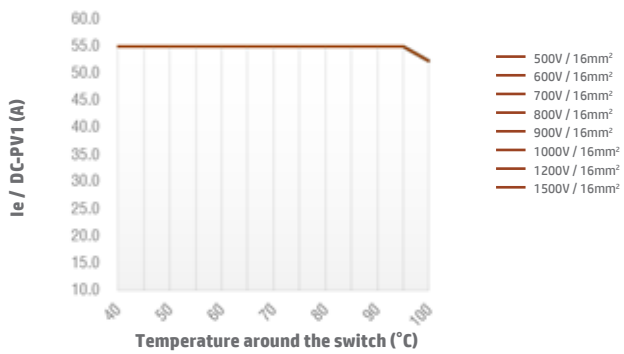

Switch SI55 4B/4S/4T DC-PV1 Enclosed Type

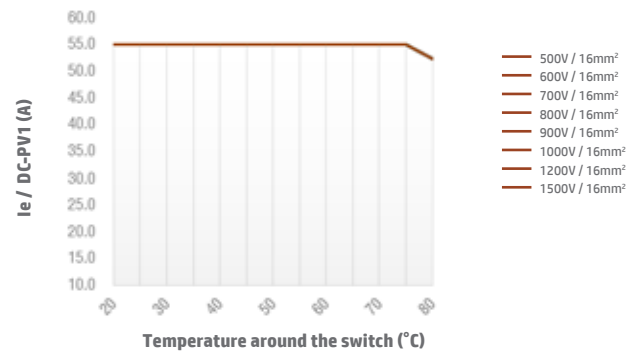

Switch SI55 4H DC-PV1 Open Type

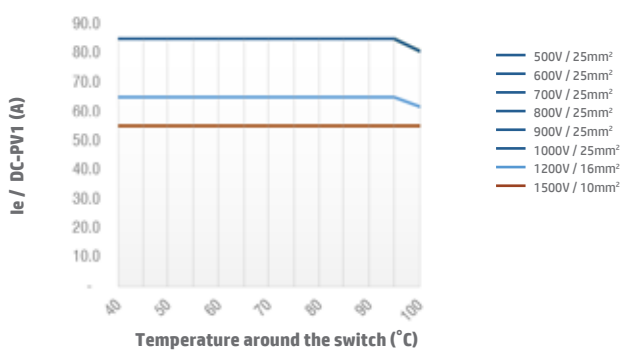

Switch SI55 4H DC-PV1 Enclosed Type

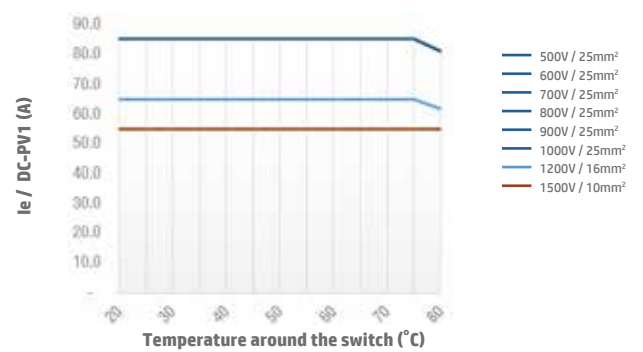

Note: SI55 3H pole configuration and SI65, DC-PV1 derating graphs can be supplied upon request. Please contact IMO for more information.

# Technical Data continued

Switch SI16 2 poles DC-PV2 Open Type

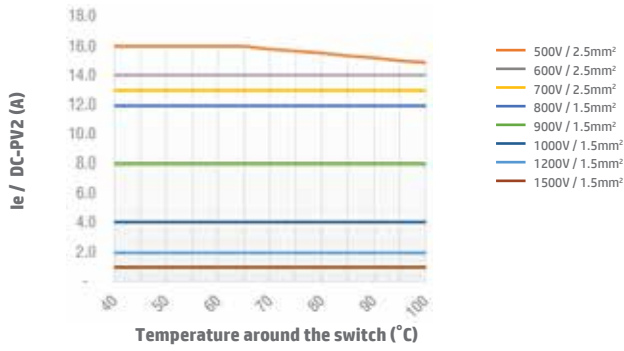

Switch SI16 2 poles DC-PV2 Enclosed Type

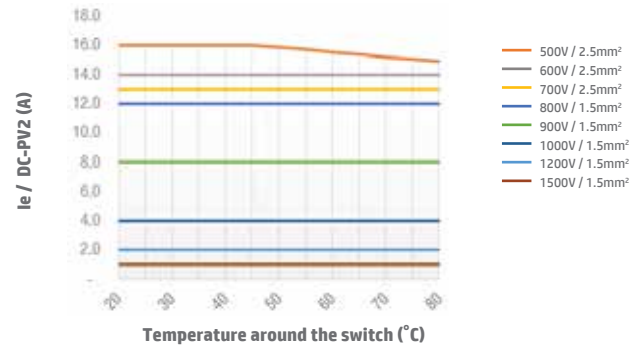

Switch SI16 2H DC-PV2 Open Type

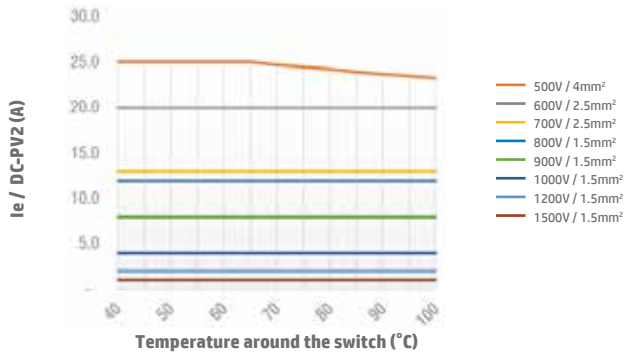

Switch SI16 2H DC-PV2 Enclosed Type

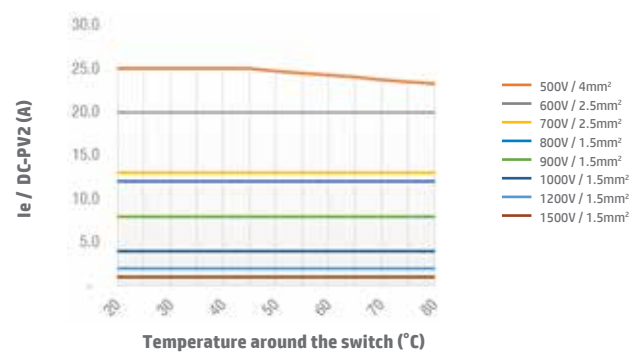

Switch SI16 4B/4S/4T DC-PV2 Open Type

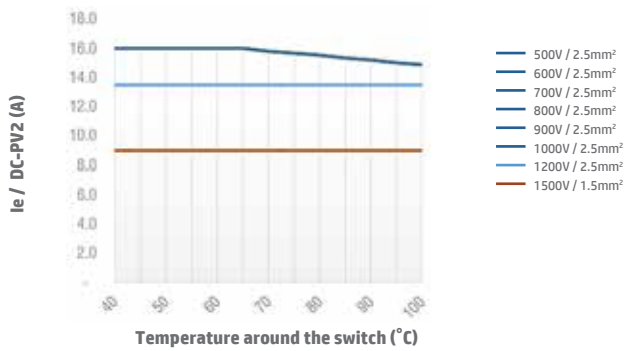

Switch SI16 4B/4S/4T DC-PV2 Enclosed Type

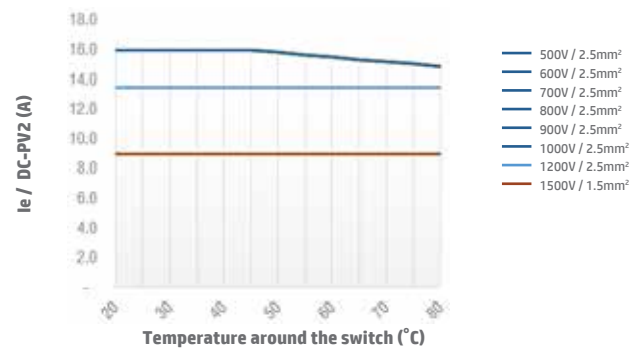

Switch SI16 4H DC-PV2 Open Type

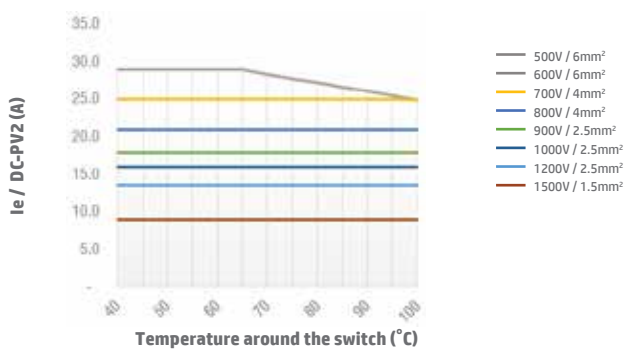

Switch SI16 4H DC-PV2 Enclosed Type

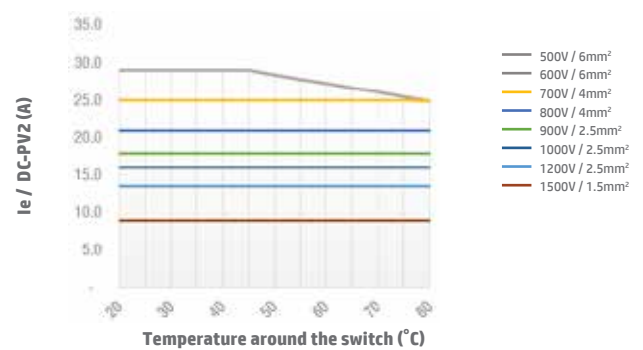

Note: For SI16 3H pole configuration, DC-PV2 derating graphs can be supplied upon request. Please contact IMO for more information.

# Technical Data continued

Switch SI25 2 poles DC-PV2 Open Type

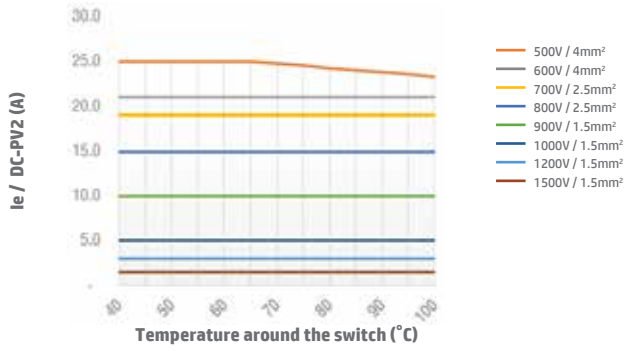

Switch SI25 2 poles DC-PV2 Enclosed Type

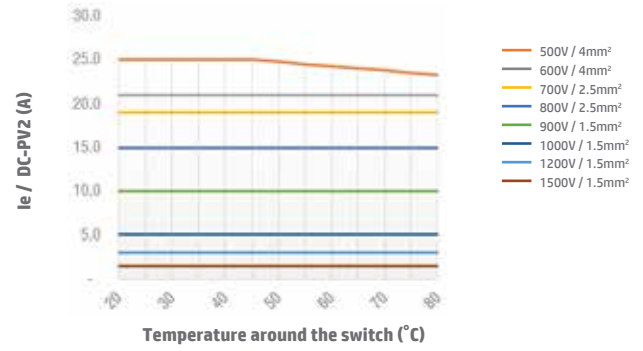

Switch SI25 2H DC-PV2 Open Type

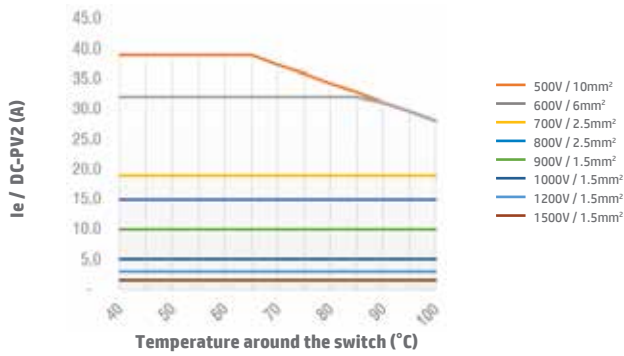

Switch SI25 2H DC-PV2 Enclosed Type

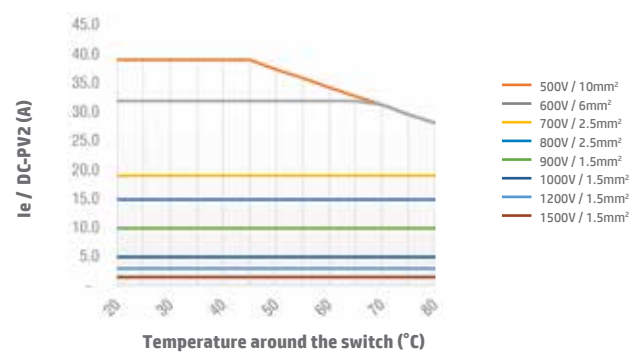

Switch SI25 4B/4S/4T DC-PV2 Open Type

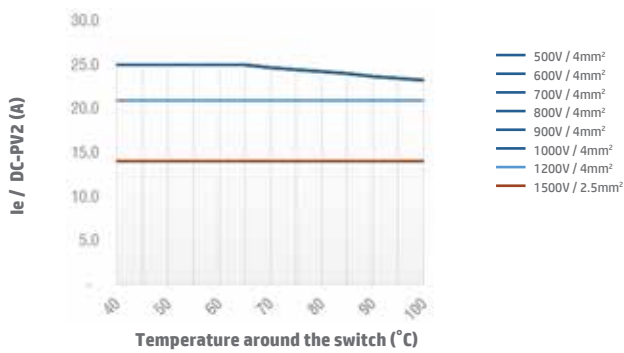

Switch SI25 4B/4S/4T DC-PV2 Enclosed Type

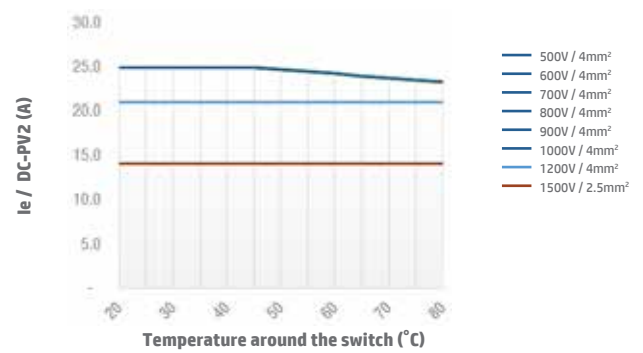

Switch SI25 4H DC-PV2 Open Type

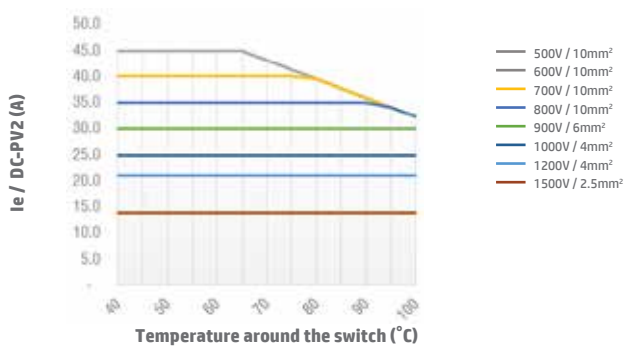

Switch SI25 4H DC-PV2 Enclosed Type

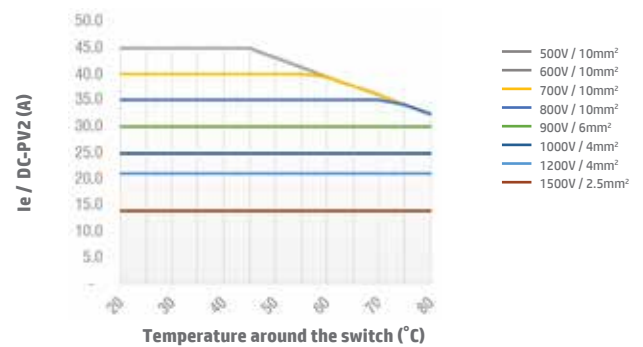

Note: For SI25 3H pole configuration, DC-PV2 derating graphs can be supplied upon request. Please contact IMO for more information.

# Technical Data continued

Switch SI32 2 poles DC-PV2 Open Type

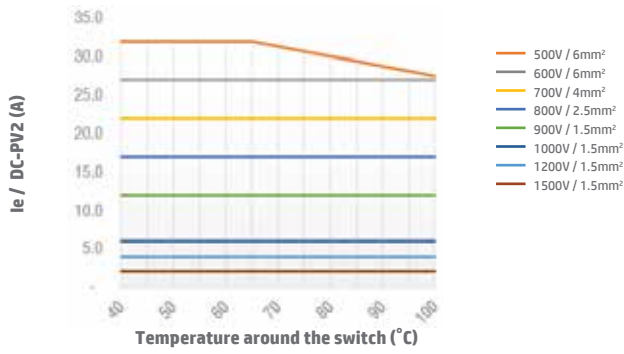

Switch SI32 2 poles DC-PV2 Enclosed Type

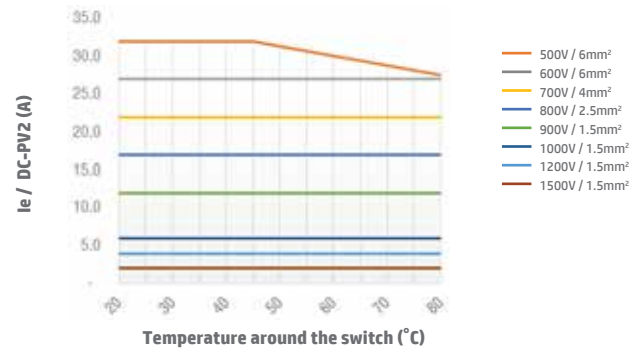

Switch SI32 2H DC-PV2 Open Type

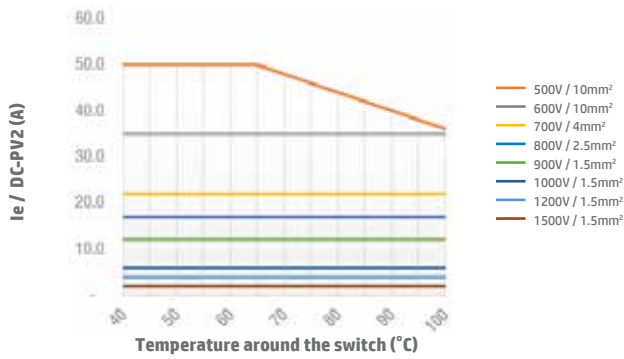

Switch SI32 2H DC-PV2 Enclosed Type

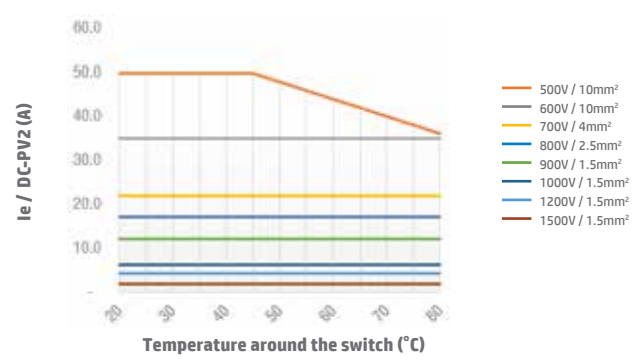

Switch SI32 4B/4S/4T DC-PV2 Open Type

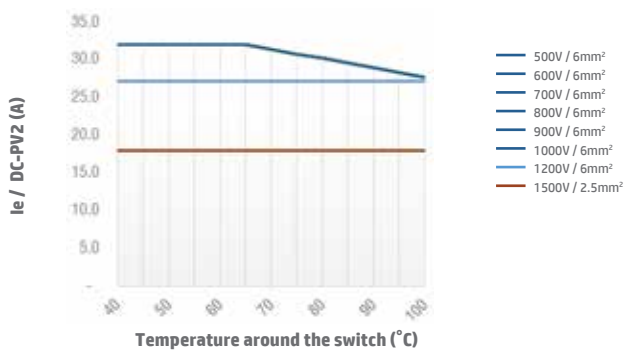

Switch SI32 4B/4S/4T DC-PV2 Enclosed Type

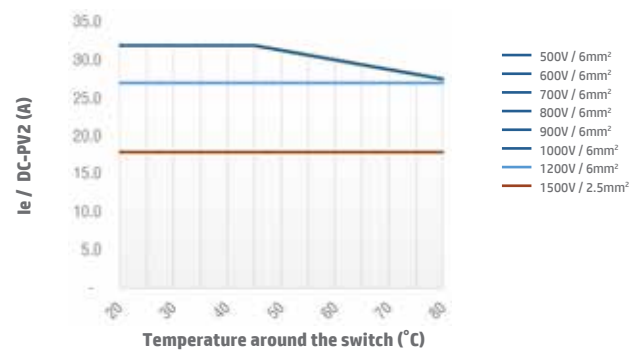

Switch SI32 4H DC-PV2 Open Type

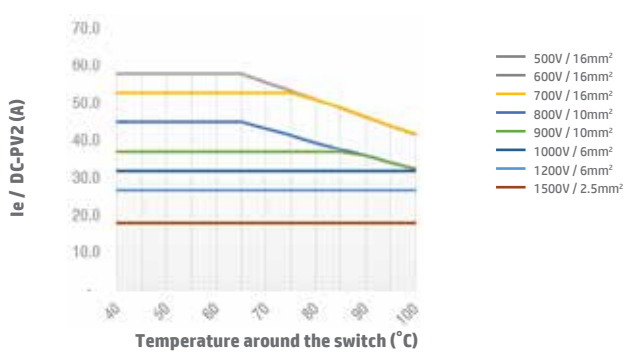

Switch SI32 4H DC-PV2 Enclosed Type

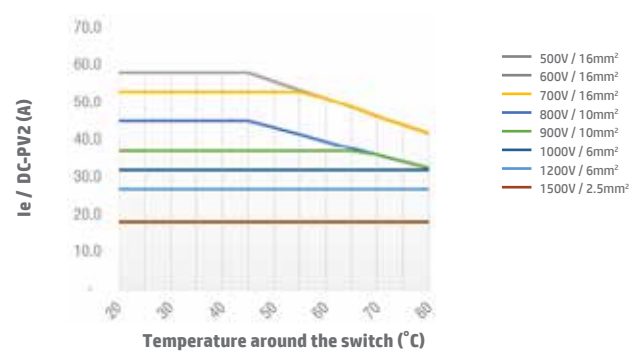

Note: For SI32 3H pole configuration, DC-PV2 derating graphs can be supplied upon request. Please contact IMO for more information.

# Technical Data continued

Switch SI38 2 poles DC-PV2 Open Type

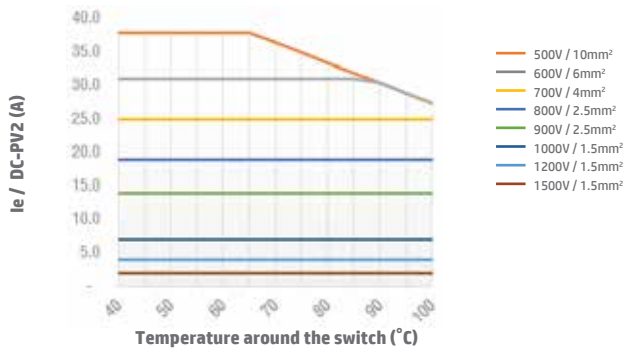

Switch SI38 2 poles DC-PV2 Enclosed Type

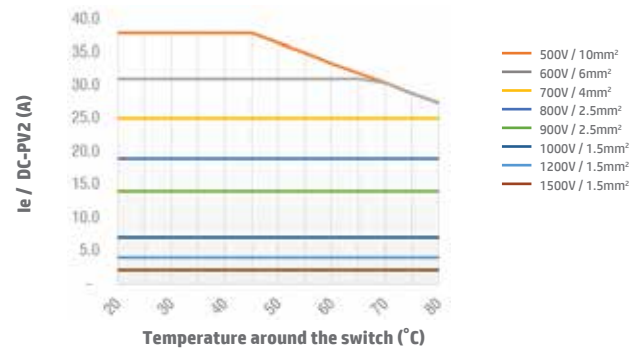

Switch SI38 2H DC-PV2 Open Type

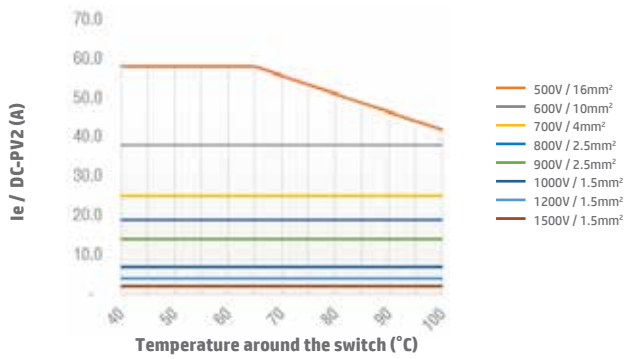

Switch SI38 2H DC-PV2 Enclosed Type

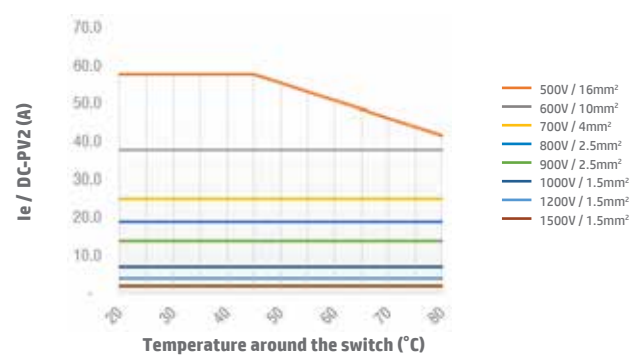

Switch SI38 4B/4S/4T DC-PV2 Open Type

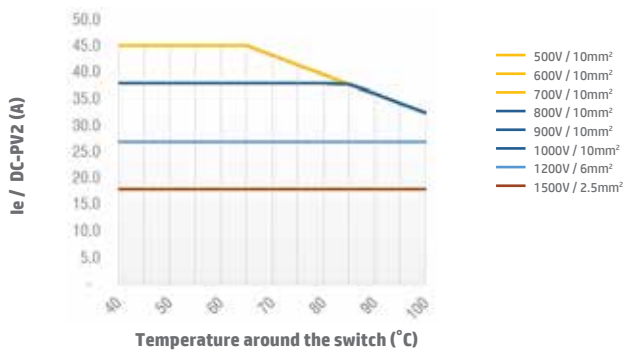

Switch SI38 4B/4S/4T DC-PV2 Enclosed Type

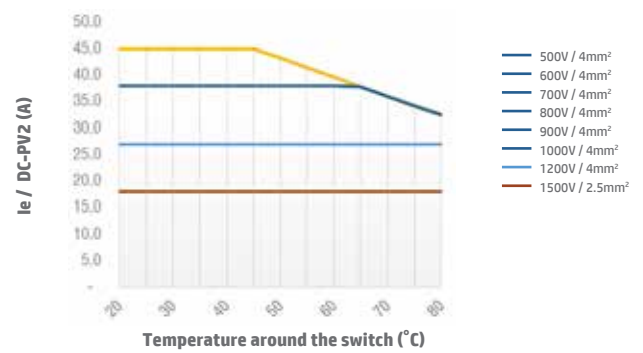

Switch SI38 4H DC-PV2 Open Type

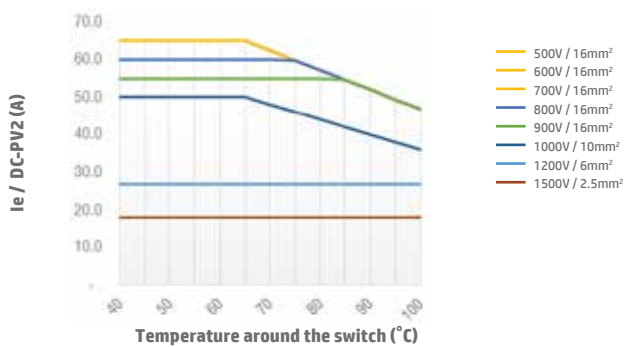

Switch SI38 4H DC-PV2 Enclosed Type

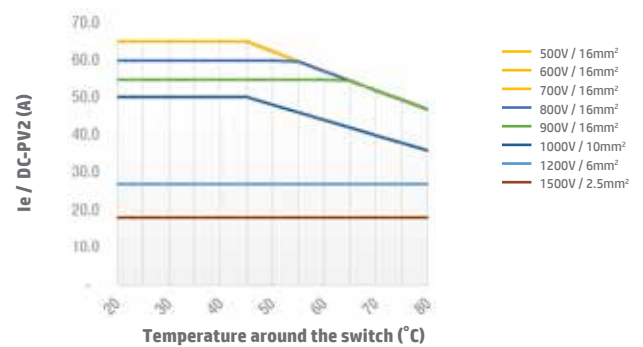

**Note:** For SI38 3H pole configuration, DC-PV2 derating graphs can be supplied upon request. Please contact IMO for more information.

# Technical Data continued

Switch SI40 2 poles DC-PV2 Open Type

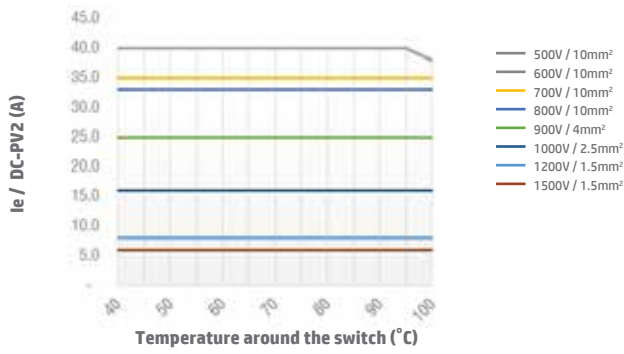

Switch SI40 2 poles DC-PV2 Enclosed Type

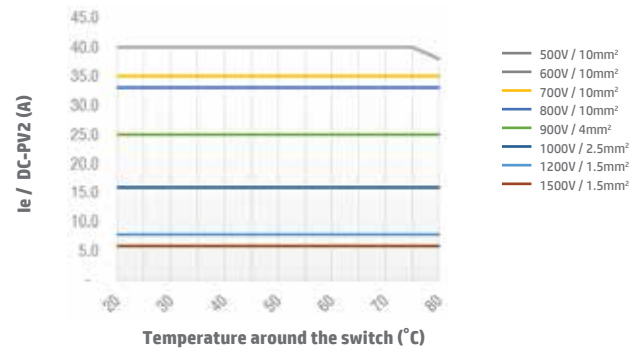

Switch SI40 2H DC-PV2 Open Type

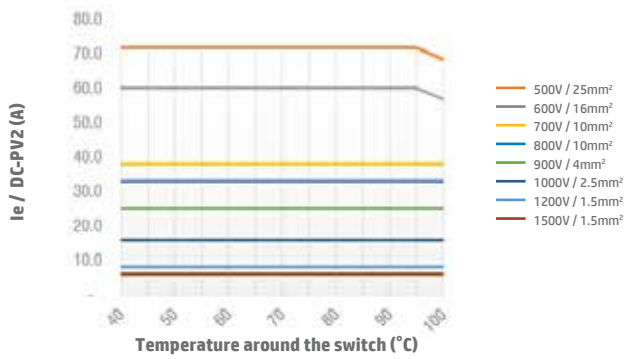

Switch SI40 2H DC-PV2 Enclosed Type

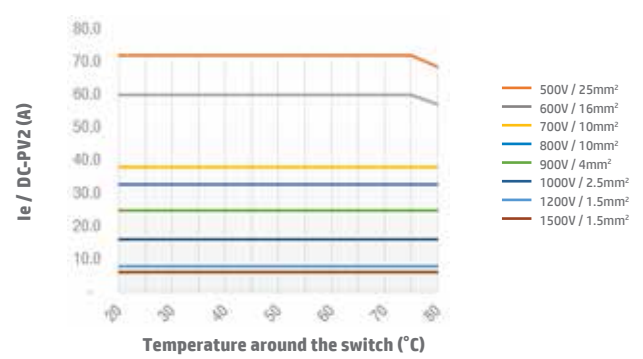

Switch SI40 4B/4S/4T DC-PV2 Open Type

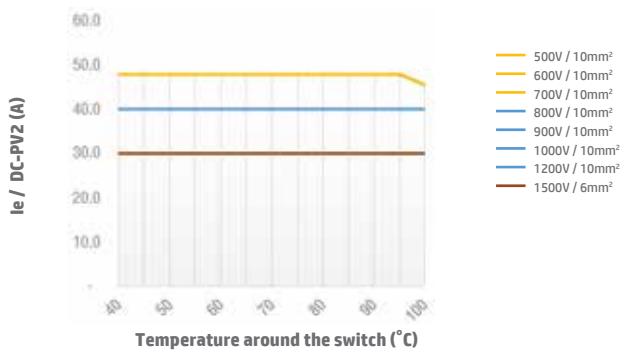

Switch SI40 4B/4S/4T DC-PV2 Enclosed Type

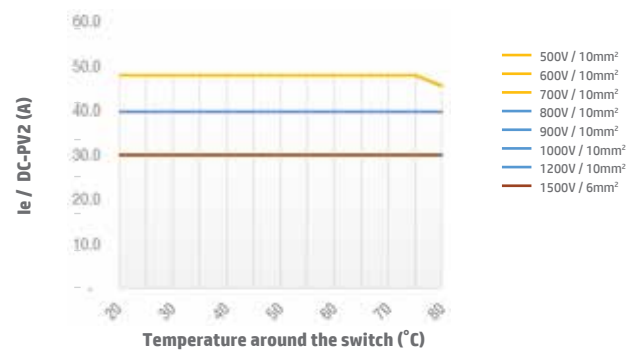

Switch SI40 4H DC-PV2 Open Type

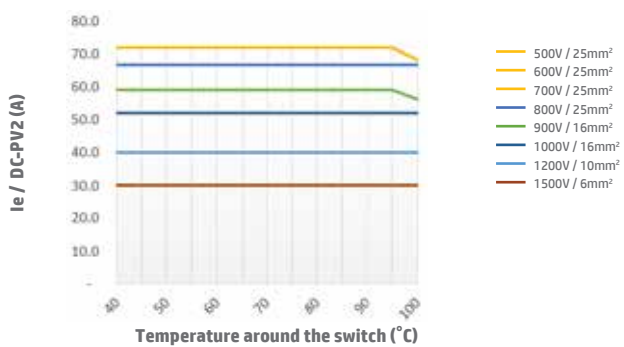

Switch SI40 4H DC-PV2 Enclosed Type

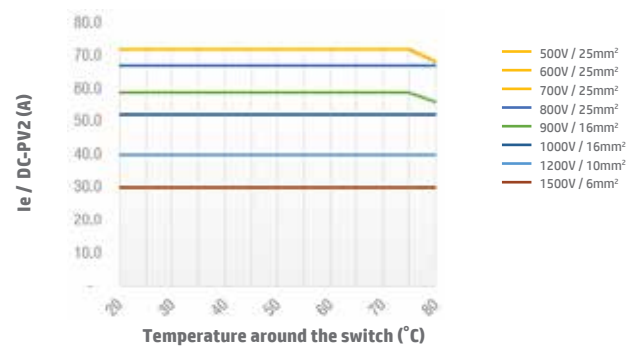

Note: For SI40 3H pole configuration, DC-PV2 derating graphs can be supplied upon request. Please contact IMO for more information.

# Technical Data continued

Switch SI55 2 poles DC-PV2 Open Type

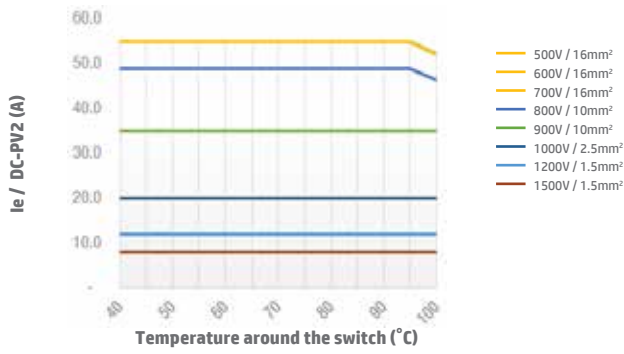

Switch SI55 2 poles DC-PV2 Enclosed Type

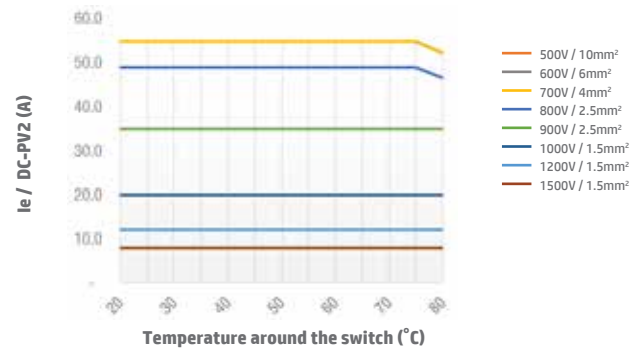

Switch SI55 2H DC-PV2 Open Type

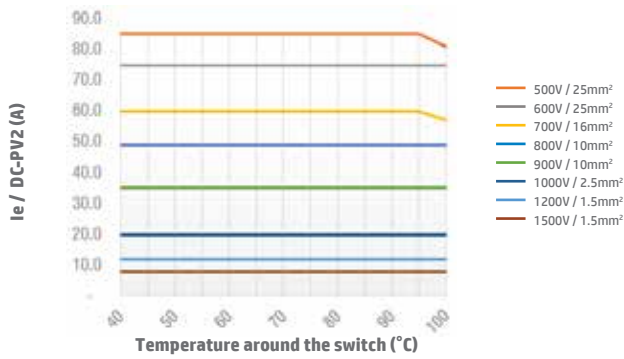

Switch SI55 2H DC-PV2 Enclosed Type

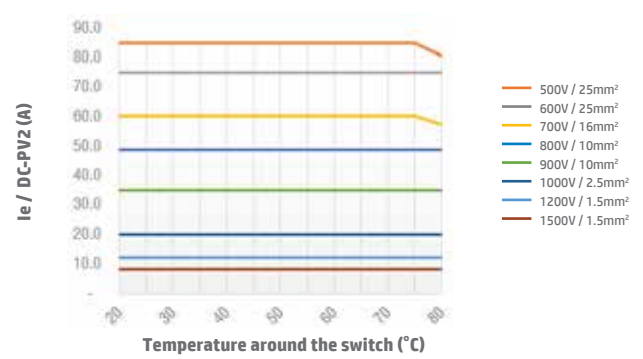

Switch SI55 4B/4S/4T DC-PV2 Open Type

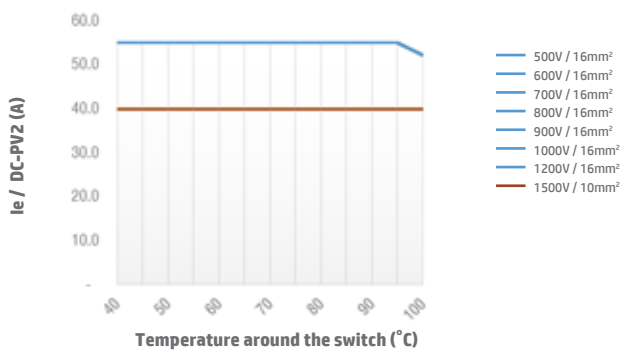

Switch SI55 4B/4S/4T DC-PV2 Enclosed Type

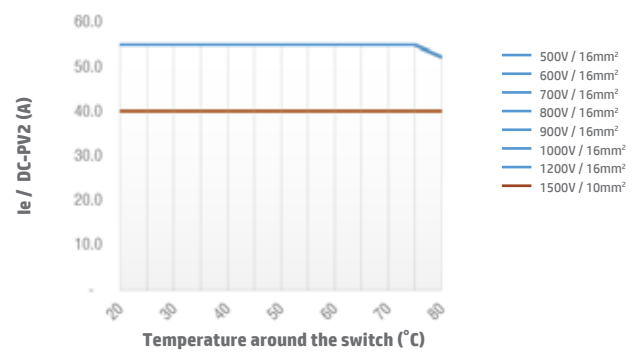

Switch SI55 4H DC-PV2 Open Type

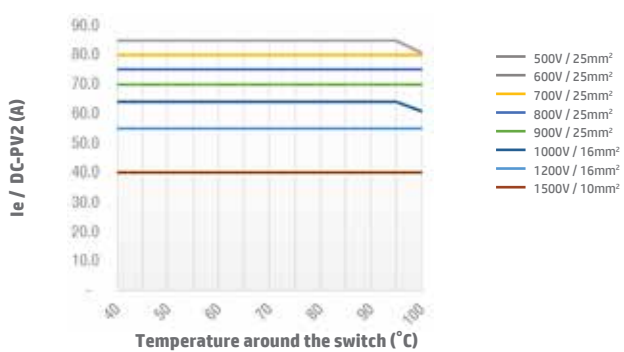

Switch SI55 4H DC-PV2 Enclosed Type

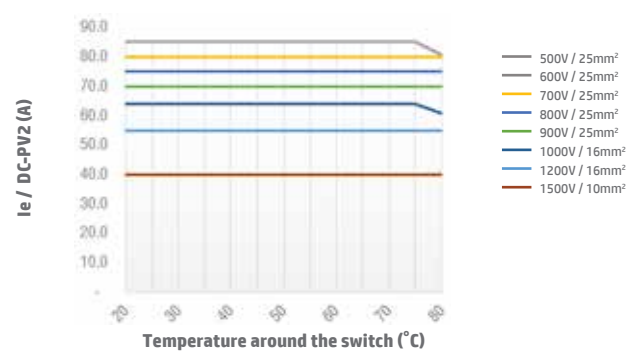

Note: SI55 3H pole configuration and SI65, DC-PV2 derating graphs can be supplied upon request. Please contact IMO for more information.



# Dimensions (mm)

SI16PM / SI25PM / SI32PM / SI38PM  
2

2H, 4

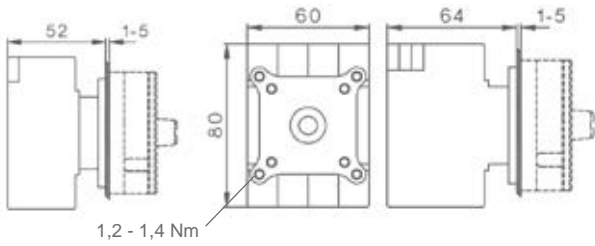

SI16PM / SI25PM / SI32PM / SI38PM  
6, 3H, 8, 4H

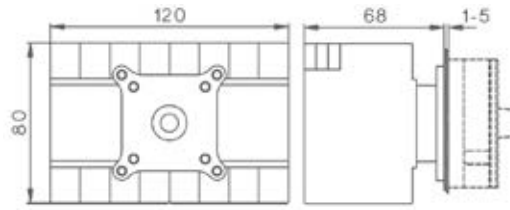

SI + X "Y"  
Extended Switch Shaft

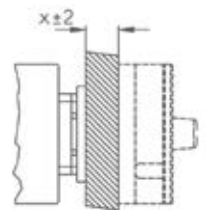

SI40PM / SI55PM / SI65PM  
2, 2H, 4

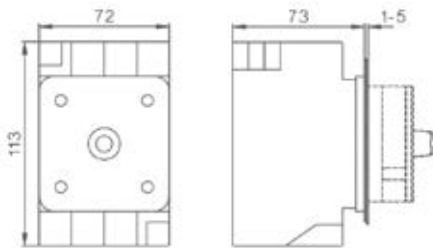

SI40PM / SI55PM / SI65PM  
6, 3H, 8, 4H

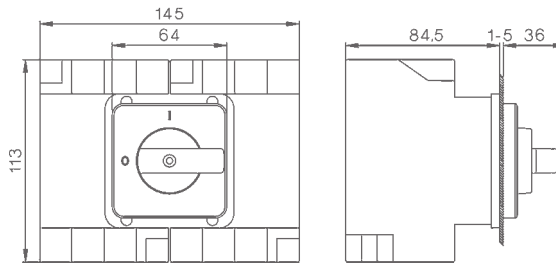

Mounting Hole

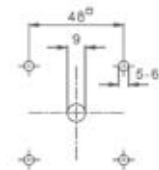

Escutcheon Plate 64  
Lever



Lockable Lever

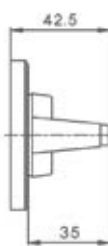
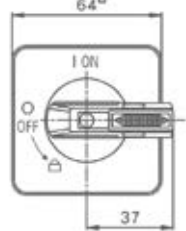

Lockable Rotary

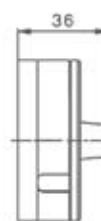

Panel Mounting

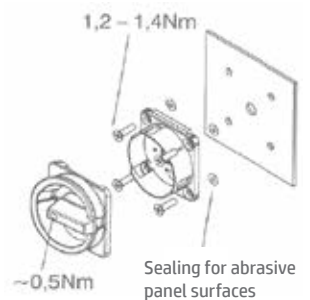

SI16SHM(L) / SI25SHM(L) / SI32SHM(L) / SI38SHM(L)  
2

2H, 4

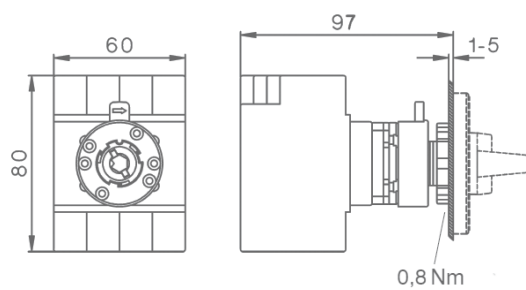
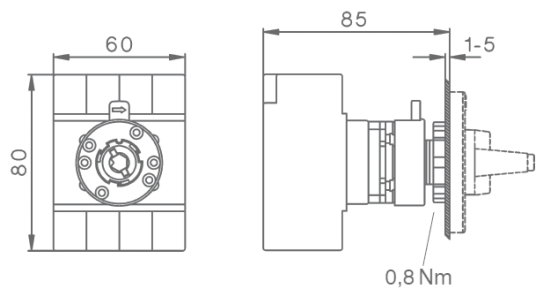

Mounting Hole

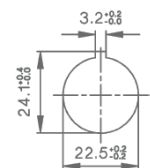

Escutcheon Plate 48  
Lever Handle

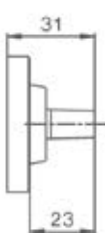

Lockable Lever

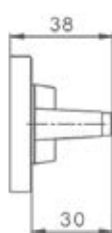
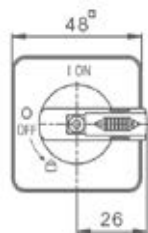

## Dimensions (mm) continued

SI16SHM(L) / SI25SHM(L) / SI32SHM(L) / SI38SHM(L)  
6, 3H, 8, 4H

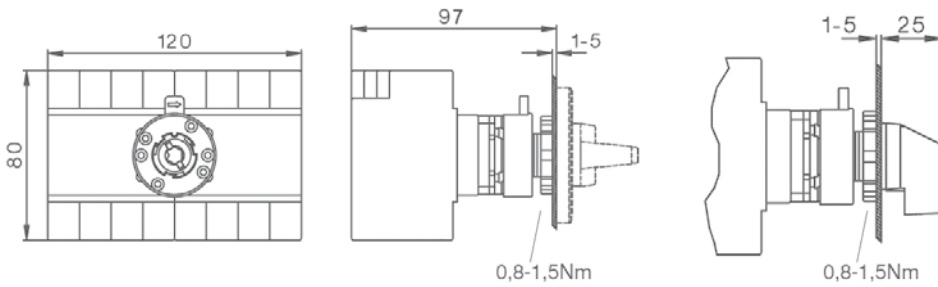

SI16BMDC / SI25BMDC / SI32BMDC / SI38BMDC  
2H, 4

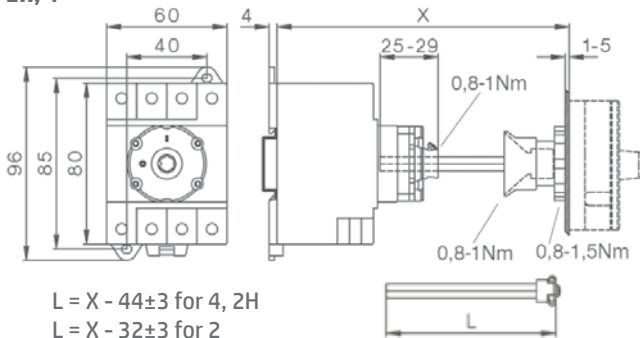

delivered with: 2H, 4  
 $X_{max.} = 194$ ,  $L = 150$   
 $(X_{min.} = 89)$

delivered with: 2  
 $X_{max.} = 182$ ,  $L = 150$   
 $(X_{min.} = 77)$

Greater X-Dimensions on request

$L = X - 44 \pm 3$  for 4, 2H  
 $L = X - 32 \pm 3$  for 2

SI16BMDC / SI25BMDC / SI32BMDC / SI38BMDC  
6, 3H, 8, 4H

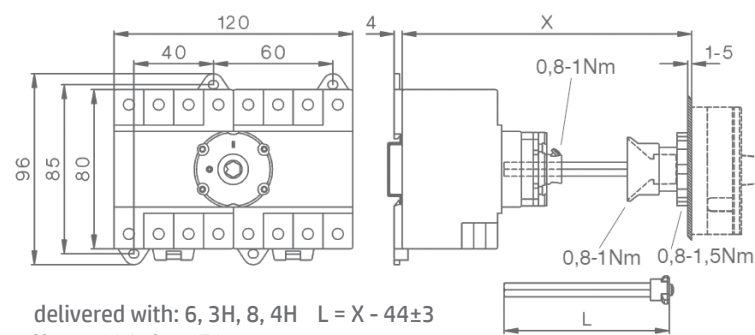

Mounting Hole

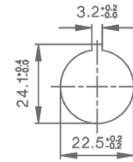

delivered with: 6, 3H, 8, 4H  $L = X - 44 \pm 3$   
 $X_{max.} = 194$ ,  $L = 150$   
 $(X_{min.} = 95)$

SI40BMDC / SI55BMDC / SI65BMDC  
2, 2H, 4

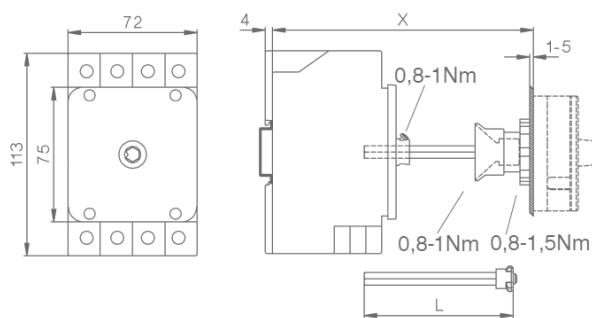

delivered with: 2, 2H, 4  $L = X - 61 \pm 3$   
 $X_{max.} = 194$ ,  $L = 133$   
 $(X_{min.} = 103)$

SI40BMDC / SI55BMDC / SI65BMDC  
6, 3H, 8, 4H

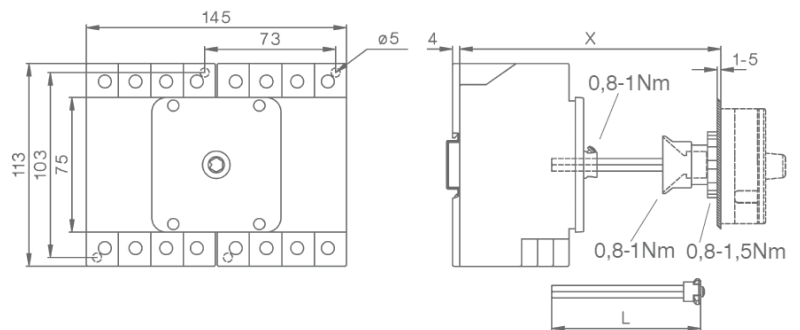

delivered with: 6, 3H, 8, 4H  $L = X - 73 \pm 3$   
 $X_{max.} = 194$ ,  $L = 121$   
 $(X_{min.} = 113)$

## Dimensions (mm) continued

SI16DB(L) / SI25DB(L) / SI32DB(L) / SI38DB(L)

2

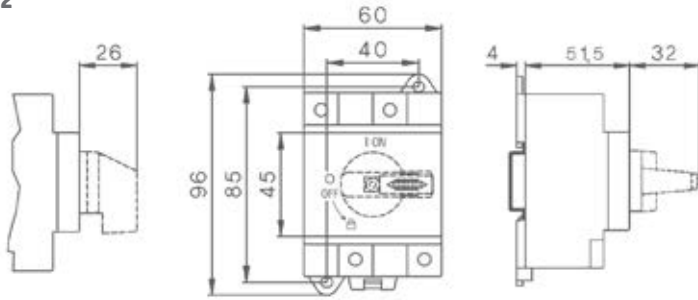

2H, 4

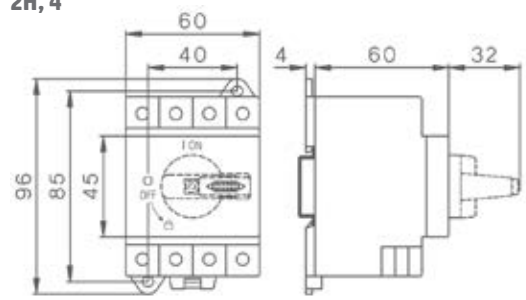

SI40DB(L) / SI55DB(L) / SI65DB(L)

2, 2H, 4

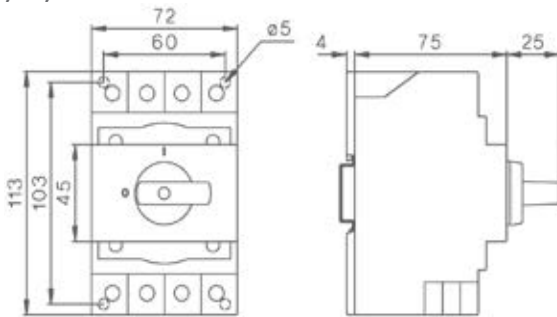

SI40DB(L) / SI55DB(L) / SI65DB(L)

6, 3H, 8, 4H

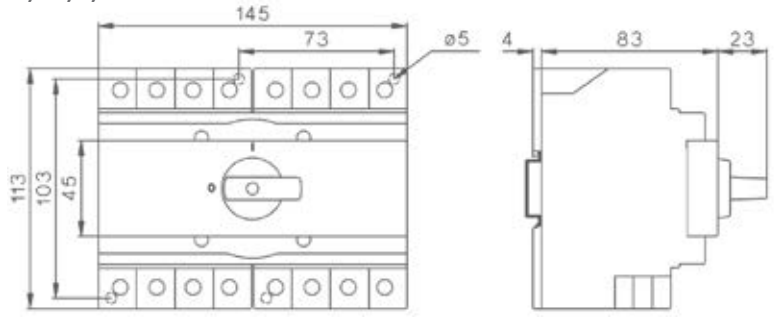

SI16DB(L) / SI25DB(L) / SI32DB(L) / SI38DB(L)

6, 3H, 8, 4H

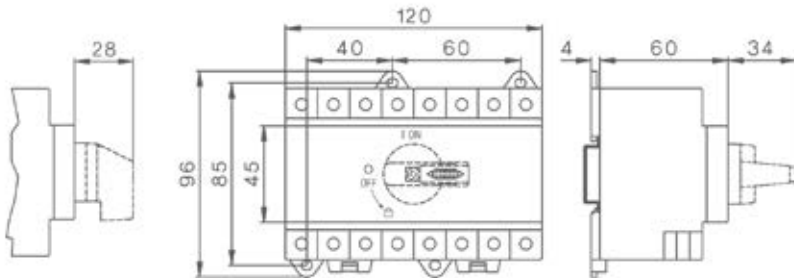

SI.. DBL with low height handle

2-LH

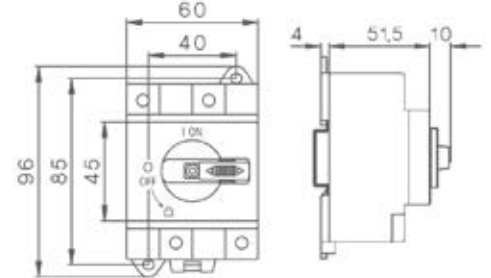

SI16DBL / SI25DBL / SI32DBL / SI38DBL with low height handle

2H-LH, 4-LH

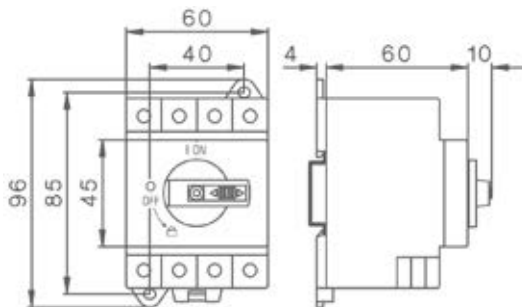

6-LH, 3H-LH, 8-LH, 4H-LH

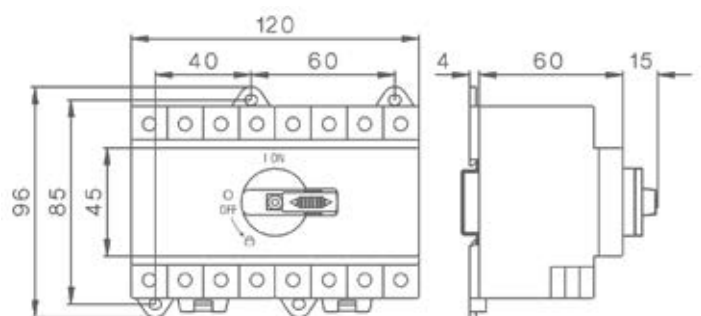

## Dimensions (mm) continued

SI16PEL / SI25PEL / SI32PEL / SI38PEL  
2, 2H, 4

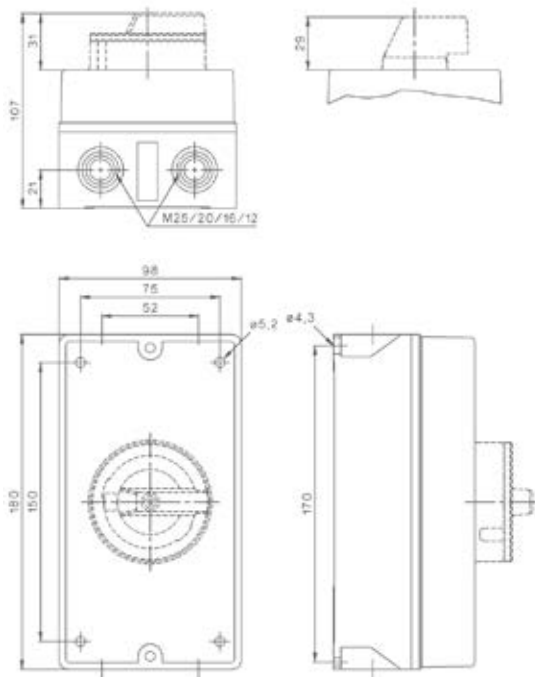

SI16PEL / SI25PEL / SI32PEL / SI38PEL  
2, 2H, 4 + M25

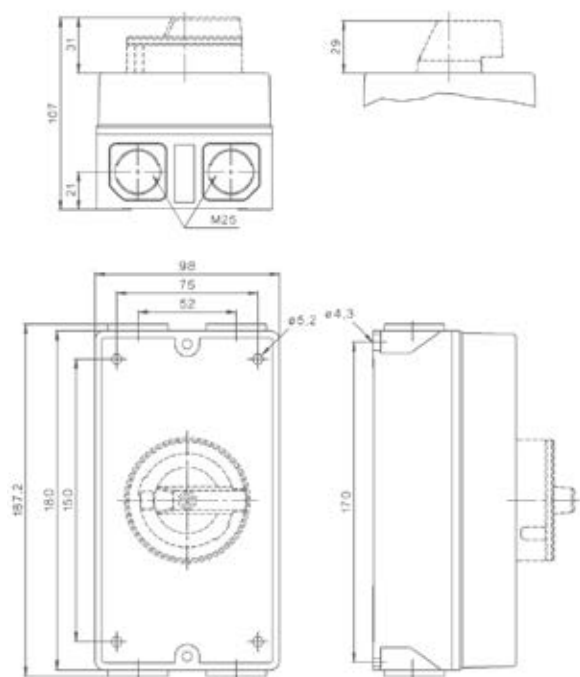

SI16PEL / SI25PEL / SI32PEL / SI38PEL  
6, 8, 3H, 4H

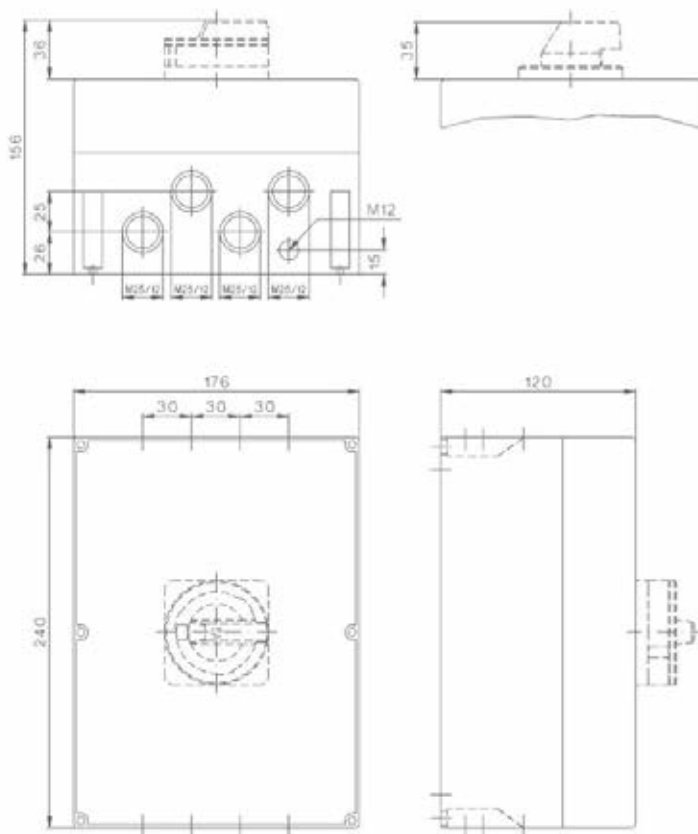

SI40PEL / SI55PEL / SI65PEL  
2, 2H, 4

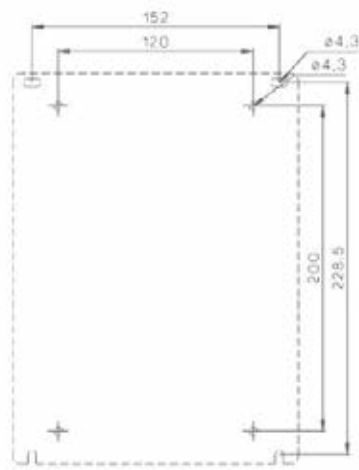

## Jumper Applications

SI16.. / SI25.. /  
SI32.. / SI38..  
2H



2x SIV-B1-1N



2x SIV-B1-1N

SI16.. / SI25.. / SI32..  
4T



2x SIV-B1-1N

SI38..  
4T



2x SIV-B1-2N

SI16.. / SI25.. /  
SI32.. / SI38..  
4H



4x SIV-B1-1N

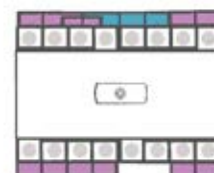

2x SIV-B1-2N

4x SIV-B1-1N

SI40.. / SI55.. / SI65..  
2H



2x SIV-B2-1N

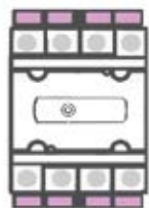

2x SIV-B2-1N

SI40.. / SI55.. / SI65..  
4T

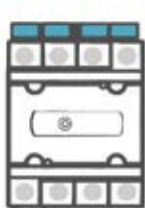

2x SIV-B2-2N

SI40.. / SI55.. / SI65..  
4H



4x SIV-B2-1N

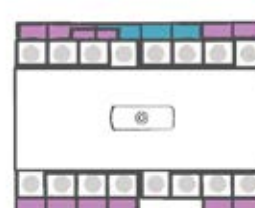

2x SIV-B2-2N

4x SIV-B2-1N

# SIM Mini Solar Isolators

## Mini TRUE DC Isolators for PV Systems

- Based on market-leading SI series design
- Compact smaller size
- Improved switching capacity
- Extended mounting options
- Guaranteed arc suppression (3ms typical)
- Operator independent switching mechanism
- Knife-edge contacts



### The next evolution in DC isolation

When IMO first launched its SI Series DC isolator in 2009, little did it know that the SI would soon become the safety component of choice for many of the largest solar inverter manufacturers and installers around the world. Today, with over 6 million installations and ZERO reported electrical failures\*, the SI Series has proved itself more than capable of handling the most demanding DC switching applications.

The NEW SIM represents the next evolution in DC isolation offering all the benefits of its big brother in a compact, high reliability package. With a 35% reduction in cubic volume, reduced front plate “real-estate”, increased ratings and extended mounting options, the SIM is packed with features. Yet it retains the high reliability technology of the current SI Series including knife edge contacts, high speed operator independent switching mechanism and full arc control with guaranteed suppression time.

The NEW SIM represents the next step in meeting the global demand for high reliability, compact and competitive DC safety switching solutions.

### Safety as standard

In solar installations, the DC isolator is like a vehicle air-bag. It is rarely called upon but, when required, carries a huge responsibility. So it's good to know that the IMO SI is safeguarding millions of solar installations around the world, without a single reported electrical failure.

Not surprising considering the product carries all the most important approvals including UL508i. In fact the IMO SI range of solar isolators have been tested by some of the most rigorous examiners and OEM manufacturers in the world, passing with flying colours every time.

### Smaller... and better

When buying IMO you can be assured of the level of quality and reliability of our products. The SIM is no exception, and just because we have managed to squeeze everything that went into our market-leading SI range into the new SIM's compact body, we haven't compromised on reliability. In fact, we have increased the overall ratings and extended the mounting options.

\* Data correct as of November 2018

### The OEM's choice

The SI range of isolators was specifically developed for arduous DC disconnect applications and SI isolators are used by many of the largest Solar Inverter manufacturers in the world.

The new SIM range features the same independent trigger ratchet switching mechanism delivering arc extinguishing times of <5ms (3ms typical). Specially designed internal arc cooling chambers control temperature rise and increase safety while knife edge contacts increase reliability and prolong electrical life.

All this along with a 35% reduction in size makes the SIM Series the ideal next generation choice for OEMs globally.

# Ordering Variations

## Lever Handle Models

|   |   |   |   |  |                                      |
|---|---|---|---|--|--------------------------------------|
| Panel Mount (4-screw)<br>64 x 64 Esc. Plate, Lever<br>Handle, IP66, NEMA 3R | Panel Mount (2-screw)<br>64 x 64 Esc. Plate, Lever<br>Handle, IP66, NEMA 3R | Single Hole Mount (22.5mm)<br>48 x 48 Esc. Plate Lever<br>Handle, IP66, NEMA 4X | Single Hole Mount (16mm)<br>No Esc. Plate, Lever Handle,<br>IP66, NEMA 4X | Base Mount (door coupling)<br>64 x 64 Esc. Plate, Lever<br>Handle, IP66, NEMA 4X | Modular Switch<br>Lever Handle, IP40 |
|   |   |   |   |  |                                      |
| <b>SIM**PM64*</b>   | <b>SIM**PMT64*</b>  | <b>SIM**SHM*</b>  | <b>SIM**SHMS*</b>   | <b>SIM**BMD64*</b>   | <b>SIM**DB*</b>                      |

## Lever Handle Models with Lockable OFF

|  |  |   |   |   |
|--|--|---|---|---|
| Panel Mount (4-screw)<br>64 x 64 Esc. Plate, Lockable<br>Lever Handle, IP66, NEMA 3R | Panel Mount (2-screw)<br>64 x 64 Esc. Plate, Lockable<br>Lever Handle, IP66, NEMA 3R | Single Hole Mount (22.5mm)<br>48 x 48 Esc. Plate, Lockable<br>Lever Handle, IP66, NEMA 4X | Base Mount (door coupling)<br>64 x 64 Esc. Plate, Lockable<br>Lever Handle, IP66, NEMA 4X | Modular Switch<br>Lockable Lever Handle, IP40 |
|  |  |   |   |   |
| <b>SIM**PML64*</b>   | <b>SIM**PMTL64*</b>  | <b>SIM**SHML*</b>   | <b>SIM**BMDCL64*</b>  | <b>SIM**DBL*</b>                              |

## Rotary Handle Models with Lockable OFF

|   |  |  |
|---|--|--|
| Panel Mount (4-screw)<br>64 x 64 Lockable Rotary<br>Handle, IP66, NEMA 3R | Base Mount (door coupling)<br>64 x 64 Lockable Rotary<br>Handle, IP66, NEMA 4X | Enclosed Version<br>Lockable Rotary Handle,<br>IP67, NEMA 4X |
|   |  |  |
| <b>SIM**PM64R*</b>  | <b>SIM**BMD64R*</b>  | <b>SIM**PEL64R*</b>  |

## Part Number Configuration

**SIM** - **16** - **PM64R** - **2**

### Series

|                                      |             |
|--------------------------------------|-------------|
| SIM Mini DC Solar Isolator (max. 4P) | <b>SIM</b>  |
| SIME Mini DC Solar Isolator          | <b>SIME</b> |

### Switch Rating

|        |           |
|--------|-----------|
| 16 Amp | <b>16</b> |
| 25 Amp | <b>25</b> |
| 32 Amp | <b>32</b> |
| 38 Amp | <b>38</b> |

### Number of Poles (see Switching Configurations on p.5)

|           |   |
|-----------|---|
| <b>2</b>  | 2-Pole  |
| <b>2H</b> | 2-Pole 4 Parallel Poles                             |
| <b>4</b>  | 4-Pole  |
| <b>4S</b> | 2-Pole 4 Poles in Series (Input Top, Output bottom) |
| <b>4T</b> | 2-Pole 4 Poles in Series (Input & Output bottom)    |
| <b>4B</b> | 2-Pole 4 Poles in Series (Input & Output top)       |
| <b>6</b>  | 6-Pole  |
| <b>8</b>  | 8-Pole  |
| <b>4H</b> | 2-Pole 8 Parallel Poles                             |

### Mounting Type

|   |               |  |                |
|---|---------------|--|----------------|
| Panel Mount (4-screw), 64 x 64 Escutcheon Plate, Lever Handle               | <b>PM64</b>   | Base Mount (DIN Rail), 64 x 64 Escutcheon Plate, Lever Handle          | <b>BMD64</b>   |
| Panel Mount (4-screw), 64 x 64 Escutcheon Plate, Lockable Lever Handle      | <b>PML64</b>  | Base Mount (DIN Rail), 64 x 64 Escutcheon Plate, Lockable Lever Handle | <b>BMDCL64</b> |
| Panel Mount (4-screw), 64 x 64 Lockable Rotary Handle                       | <b>PM64R</b>  | Base Mount (DIN Rail), 64 x 64 Lockable Rotary Handle                  | <b>BMD64R</b>  |
| Panel Mount (2-screw), 64 x 64 Escutcheon Plate, Lever Handle               | <b>PMT64</b>  | Base Mount (2 mounting lugs), 64 x 64 Lockable Rotary Handle           | <b>BMS64R*</b> |
| Panel Mount (2-screw), 64 x 64 Escutcheon Plate, Lockable Lever Handle      | <b>PMTL64</b> | Modular Switch, Lever Handle   | <b>DB</b>      |
| Single Hole (22.5mm) Mount, 48 x 48 Escutcheon Plate, Lever Handle          | <b>SHM</b>    | Modular Switch, Lockable Lever Handle                                  | <b>DBL</b>     |
| Single Hole (22.5mm) Mount, 48 x 48 Escutcheon Plate, Lockable Lever Handle | <b>SHML</b>   | Enclosed Version, Lockable Rotary Handle                               | <b>PEL64R</b>  |
| Single Hole (16mm) Mount, No Escutcheon Plate, Lever Handle                 | <b>SHMS</b>   |  |                |

\* SIM only

## Switching Configurations

| Type                         | 2-pole | 2-pole<br>4 parallel poles | 4-pole | 4 poles in series<br>Input on top Output<br>bottom | 4 poles in series<br>Input and Output<br>bottom | 4 poles in series<br>Input and Output on top |
|------------------------------|--------|----------------------------|--------|--|---|--|
| <b>SIM(E)16</b>              | 2      | 2H                         | 4      | 4S   | 4T  | 4B   |
| <b>SIM(E)25</b>              | 2      | 2H                         | 4      | 4S   | 4T  | 4B   |
| <b>SIM(E)32</b>              | 2      | 2H                         | 4      | 4S   | 4T  | 4B   |
| <b>SIM(E)38</b>              | 2      | 2H                         | 4      | 4S   | 4T  | 4B   |
| Contact<br>Wiring<br>Diagram |        |                            |        |  |   |  |
| Switching<br>Example         |        |                            |        |  |   |  |

| Type                          | 6-pole | 8-pole | 2-pole<br>8 parallel poles |
|-------------------------------|--------|--------|----------------------------|
| <b>SIME16</b>                 | 6      | 8      | 4H                         |
| <b>SIME25</b>                 | 6      | 8      | 4H                         |
| <b>SIME32</b>                 | 6      | 8      | 4H                         |
| <b>SIME38</b>                 | 6      | 8      | 4H                         |
| Contacts<br>Wiring<br>Diagram |        |        |                            |
| Switching<br>example          |        |        |                            |

## Insulated Jumper

for series and parallel switching of contacts

| Type           | SIM16                      | SIM25 | SIM32                      | SIM38 |
|----------------|----------------------------|-------|----------------------------|-------|
| <b>4T / 4B</b> | 2x SIMV-B1-1N              |       | 2x SIMV-B1-2N              |       |
| <b>2H</b>      | 4x SIMV-B1-1N              |       |                            |       |
| <b>4S</b>      | 1x SIMV-B1-1N & 1x LG11852 |       | 1x SIMV-B1-2N & 1x LG11852 |       |



**WARNING:** Verify that all connections (including bridging link connections) are suitable for the rated current, prepared to ensure only conductive parts are clamped and tightened to the manufacturer's required torque before energisation.

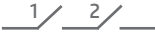
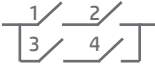
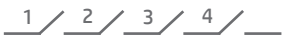
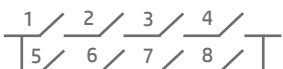

## Technical Data for DC according to IEC 60947-3

| Type  |           | DC-PV1 |      |      |      |      |       |       |       | DC-PV2 |      |      |       |
|---|-----------|--------|------|------|------|------|-------|-------|-------|--------|------|------|-------|
|   |           | 500V   | 600V | 700V | 800V | 900V | 1000V | 1200V | 1500V | 500V   | 600V | 800V | 1000V |
| 2 poles in series<br>2<br>               | SIM16 ..  | 16A    | 16A  | 16A  | 16A  | 16A  | 10A   | 7A    | 3A    | 16A    | 14A  | 12A  | 4A    |
|   | SIM25 ..  | 25A    | 25A  | 25A  | 20A  | 17A  | 11.5A | 8.5A  | 5A    | 25A    | 21A  | 15A  | 5A    |
|   | SIM32 ..  | 32A    | 32A  | 32A  | 23A  | 20A  | 13A   | 10A   | 6A    | 32A    | 27A  | 17A  | 6A    |
|   | SIM38 ..  | 45A    | 45A  | 36A  | 30A  | 25A  | 20A   | 10A   | 6A    | 38A    | 31A  | 19A  | 7A    |
| 2 poles in series + 2 parallel<br>2H<br> | SIM16 ..  | 29A    | 29A  | 22A  | 17A  | 16A  | 10A   | 7A    | 3A    | 25A    | 20A  | 12A  | 4A    |
|   | SIM25 ..  | 45A    | 36A  | 27A  | 20A  | 17A  | 11.5A | 8.5A  | 5A    | 39A    | 32A  | 15A  | 5A    |
|   | SIM32 ..  | 50A    | 50A  | 32A  | 23A  | 20A  | 13A   | 10A   | 6A    | 50A    | 35A  | 17A  | 6A    |
|   | SIM38 ..  | 50A    | 50A  | 36A  | 30A  | 25A  | 20A   | 10A   | 6A    | 50A    | 38A  | 19A  | 7A    |
| 4 poles in series<br>4S, 4B, 4T<br>      | SIM16 ..  | 16A    | 16A  | 16A  | 16A  | 16A  | 16A   | 16A   | 16A   | 16A    | 16A  | 16A  | 16A   |
|   | SIM25 ..  | 25A    | 25A  | 25A  | 25A  | 25A  | 25A   | 25A   | 25A   | 25A    | 25A  | 25A  | 25A   |
|   | SIM32 ..  | 32A    | 32A  | 32A  | 32A  | 32A  | 32A   | 32A   | 32A   | 32A    | 32A  | 32A  | 32A   |
|   | SIM38 ..  | 45A    | 45A  | 45A  | 45A  | 45A  | 38A   | 32A   | 32A   | 45A    | 45A  | 38A  | 38A   |
| 4 poles in series + 2 parallel<br>4H<br> | SIME16 .. | 29A    | 29A  | 29A  | 29A  | 29A  | 29A   | 29A   | 20A   | 29A    | 29A  | 21A  | 16A   |
|   | SIME25 .. | 45A    | 45A  | 45A  | 45A  | 45A  | 45A   | 33A   | 26A   | 45A    | 45A  | 35A  | 25A   |
|   | SIME32 .. | 50A    | 50A  | 50A  | 50A  | 50A  | 50A   | 50A   | 32A   | 50A    | 50A  | 45A  | 32A   |
|   | SIME38 .. | 50A    | 50A  | 50A  | 50A  | 50A  | 50A   | 50A   | 32A   | 50A    | 50A  | 50A  | 50A   |

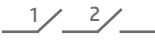
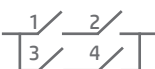
## Technical Data for DC according to UL508i

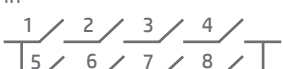
| Type  |           | UL508i |      |      |      |
|---|-----------|--------|------|------|------|
|   |           | 200V   | 350V | 500V | 600V |
| 2 poles in series<br>2<br>               | SIM16 ..  | 16A    | 16A  | 16A  | 16A  |
|   | SIM25 ..  | 25A    | 25A  | 25A  | 25A  |
|   | SIM32 ..  | 32A    | 32A  | 32A  | 32A  |
|   | SIM38 ..  | 38A    | 38A  | 38A  | 36A  |
| 2 poles in series + 2 parallel<br>2H<br> | SIM16 ..  | 29A    | 29A  | 29A  | 21A  |
|   | SIM25 ..  | 45A    | 45A  | 41A  | 30A  |
|   | SIM32 ..  | 50A    | 50A  | 43A  | 33A  |
|   | SIM38 ..  | 50A    | 50A  | 45A  | 36A  |
| 4 poles in series<br>4S, 4B, 4T<br>      | SIM16 ..  | 16A    | 16A  | 16A  | 16A  |
|   | SIM25 ..  | 25A    | 25A  | 25A  | 25A  |
|   | SIM32 ..  | 32A    | 32A  | 32A  | 32A  |
|   | SIM38 ..  | 38A    | 38A  | 38A  | 36A  |
| 4 poles in series + 2 parallel<br>4H<br> | SIME16 .. | 29A    | 29A  | 29A  | 21A  |
|   | SIME25 .. | 45A    | 45A  | 45A  | 45A  |
|   | SIME32 .. | 50A    | 50A  | 50A  | 50A  |
|   | SIME38 .. | 50A    | 50A  | 50A  | 50A  |

# Technical Data

Data according to IEC 60947-3, VDE 0660, GB14048.3

| Main Contacts  |                   | Type                  | SIM(E)16        | SIM(E)25                                     | SIM(E)32 | SIM(E)38 |          |
|--|-------------------|-----------------------|-----------------|--|----------|----------|----------|
| Rated thermal current $I_{the}$  |                   | A                     | 16              | 25   | 32       | 38       |          |
| Rated insulation voltage $U_i^{1)}$  |                   | V                     | 1000            | 1000   | 1000     | 1000     |          |
| Rated insulation voltage $U_i^{2)}$  |                   | V                     | 1500            | 1500   | 1500     | 1500     |          |
| Distance of contacts (per pole)  |                   | mm                    | 8               | 8  | 8        | 8        |          |
| <b>Rated operational current <math>I_e</math></b><br><br><b>DC21A</b><br><br> | 1 pole            |                       |                 |  |          |          |          |
|  | 1                 |                       |                 |  |          |          |          |
|  | 300V              | A                     | 16              | 23   | 27       | -        |          |
|  | 400V              | A                     | 12              | 14   | 16       | -        |          |
|  | 500V              | A                     | 9               | 11   | 13       | -        |          |
|  | 600V              | A                     | 6               | 8  | 10       | -        |          |
|  | 700V              | A                     | 4.5             | 6  | 7.5      | -        |          |
|  | 800V              | A                     | 3               | 4  | 5        | -        |          |
|  | 900V              | A                     | 2.5             | 3  | 4        | -        |          |
|  | 1000V             | A                     | 1.5             | 2  | 2.5      | -        |          |
|  | 2 poles in series |                       |                 |  |          |          |          |
|  | 2                 |                       |                 |  |          |          |          |
|  | 500V              | A                     | 16              | 25   | 32       | -        |          |
|  | 600V              | A                     | 16              | 25   | 32       | -        |          |
|  | 700V              | A                     | 16              | 23   | 27       | -        |          |
|  | 800V              | A                     | 16              | 20   | -        | -        |          |
|  | 900V              | A                     | 13              | 16   | -        | -        |          |
|  | 1000V             | A                     | 9               | 11   | 13       | -        |          |
|  | 1200V             | A                     | 6               | 8  | 10       | -        |          |
|  | 1500V             | A                     | 3               | 4  | 5        | -        |          |
| 2 poles in series<br>+ 2 poles parallel  |                   |                       |                 |  |          |          |          |
| 2H   |                   |                       |                 |  |          |          |          |
| 500V   | A                 | 29                    | 45              | 50   | -        |          |          |
| 600V   | A                 | 29                    | 45              | 50   | -        |          |          |
| 700V   | A                 | 16                    | 23              | 27   | -        |          |          |
| 800V   | A                 | 16                    | 20              | -  | -        |          |          |
| 900V   | A                 | 13                    | 16              | -  | -        |          |          |
| 1000V  | A                 | 9                     | 11              | 13   | -        |          |          |
| 1200V  | A                 | 6                     | 8               | 10   | -        |          |          |
| 1500V  | A                 | 3                     | 4               | 5  | -        |          |          |
| 4 poles in series  |                   |                       |                 |  |          |          |          |
| 4S, 4B, 4T   |                   |                       |                 |  |          |          |          |
| 500V   | A                 | 16                    | 25              | 32   | -        |          |          |
| 600V   | A                 | 16                    | 25              | 32   | -        |          |          |
| 700V   | A                 | 16                    | 25              | 32   | -        |          |          |
| 800V   | A                 | 16                    | 25              | 32   | -        |          |          |
| 900V   | A                 | 16                    | 25              | 32   | -        |          |          |
| 1000V  | A                 | 16                    | 25              | 32   | -        |          |          |
| 1200V  | A                 | 16                    | 25              | 32   | -        |          |          |
| 1500V  | A                 | 16                    | 20              | 23   | -        |          |          |
| <b>Rated operational current <math>I_e</math></b>  |                   |                       |                 |  |          |          |          |
| AC21B  | 2, 4              | $U_e$ max. 440V       | A               | 16   | 25       | 32       | 45       |
|  | 2H                | $U_e$ max. 440V       | A               | 29   | 45       | 50       | -        |
| <b>Rated conditional short circuit current</b>   |                   |                       | $kA_{eff}$      | 5  | 5        | 5        | 5        |
| Max. fuse size   |                   | gL (gG)               | A               | 40   | 63       | 80       | 80       |
| Mechanical life  |                   |                       | $\times 10^3$   | 10   | 10       | 10       | 10       |
| Rated short-time withstand current (1s)  | $I_{cw}$          | 2, 4                  | A               | 800  | 900      | 1000     | 1000     |
|  |                   | 2H                    | A               | 1300   | 1500     | 1700     | 1700     |
| Short circuit making capacity  | $I_{cm}$          | 2, 4                  | A               | 800  | 900      | 1000     | 1000     |
|  |                   | 2H                    | A               | 1300   | 1500     | 1700     | 1700     |
| Maximum cable cross sections   |                   | (inc. jumper SIMV-B1) |                 |  |          |          |          |
| solid stranded   |                   |                       | mm <sup>2</sup> | 1.5 - 10                                     | 1.5 - 10 | 1.5 - 10 | 1.5 - 10 |
| flexible   |                   |                       | mm <sup>2</sup> | 1.5 - 6                                      | 1.5 - 6  | 1.5 - 6  | 1.5 - 6  |
| flexible (+ multicore cable end)   |                   |                       | mm <sup>2</sup> | 1.5 - 6                                      | 1.5 - 6  | 1.5 - 6  | 1.5 - 6  |
| Size of terminal screw   |                   |                       |                 | M4 Pz1                                       | M4 Pz1   | M4 Pz1   | M4 Pz1   |
| Tightening torque  |                   |                       | Nm              | 1.4  | 1.4      | 1.4      | 1.4      |
| 2 cables per clamp without jumper SIMV-B1  |                   |                       |                 |  |          |          |          |
| solid or stranded  |                   |                       | mm <sup>2</sup> | 2 x 0.5mm <sup>2</sup> to 2x6mm <sup>2</sup> |          |          |          |
| <b>Maximum ambient temperature</b>   |                   |                       |                 |  |          |          |          |
| Operation  | open              |                       | °C              | -40 to +65                                   |          |          |          |
|  | enclosed          |                       | °C              | -40 to +45                                   |          |          |          |
| Storage  |                   |                       | °C              | -50 to +90                                   |          |          |          |
| Contact Resistance per pole  |                   |                       | mΩ              | 1.75   |          |          |          |

1) Suitable at overvoltage category I to III, pollution degree 3 (standard-industry):  $U_{imp} = 8kV$ .

2) Suitable at overvoltage category I to III, pollution degree 2 (min.IP55):  $U_{imp} = 8kV$ .

# Technical Data

Data according to IEC 60947-3, VDE 0660, GB14048.3

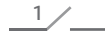
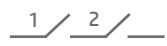
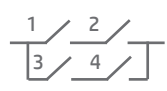
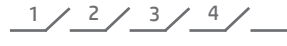

| Main Contacts  |  | Type  | SIM(E)16 | SIM(E)25 | SIM(E)32 | SIM(E)38 |    |    |    |
|--|--|---|----------|----------|----------|----------|----|----|----|
| Rated thermal current $I_{the}$  |  | A   | 16       | 25       | 32       | 38       |    |    |    |
| Rated insulation voltage $U_i$ <sup>1)</sup>   |  | V   | 1000     | 1000     | 1000     | 1000     |    |    |    |
| Rated insulation voltage $U_i$ <sup>2)</sup>   |  | V   | 1500     | 1500     | 1500     | 1500     |    |    |    |
| Distance of contacts (per pole)  |  | mm  | 8        | 8        | 8        | 8        |    |    |    |
| <b>DC21B</b>   | 1 pole<br>1<br>                                   | 300V  | A        | -        | -        | -        | -  |    |    |
|  |  | 400V  | A        | -        | -        | -        | -  |    |    |
|  |  | 500V  | A        | -        | -        | -        | -  |    |    |
|  |  | 600V  | A        | -        | -        | -        | -  |    |    |
|  |  | 700V  | A        | -        | -        | -        | -  |    |    |
|  |  | 800V  | A        | -        | -        | -        | -  |    |    |
|  |  | 900V  | A        | -        | -        | -        | -  |    |    |
|  |  | 1000V   | A        | -        | -        | -        | -  |    |    |
|  |  | 2 poles in series<br>2<br> |          | 500V     | A        | 16       | 25 | 32 | 45 |
|  |  |   |          | 600V     | A        | 16       | 25 | 32 | 45 |
|  |  |   | 700V     | A        | 16       | 25       | 32 | 36 |    |
|  |  |   | 800V     | A        | 16       | 20       | 23 | 30 |    |
|  |  |   | 900V     | A        | 16       | 17       | 20 | 25 |    |
|  |  |   | 1000V    | A        | 10       | 11.5     | 13 | 20 |    |
|  |  |   | 1200V    | A        | 7        | 8.5      | 10 | 10 |    |
|  |  |   | 1500V    | A        | 3        | 5        | 6  | 6  |    |
|  | 2 poles in series<br>+ 2 poles parallel<br>2H<br> |   | 500V     | A        | 29       | 45       | 50 | 50 |    |
|  |  |   | 600V     | A        | 29       | 45       | 50 | 50 |    |
|  |  |   | 700V     | A        | 22       | 27       | 32 | 36 |    |
|  |  |   | 800V     | A        | 17       | 20       | 23 | 30 |    |
|  |  | 900V  | A        | 16       | 17       | 20       | 25 |    |    |
|  |  | 1000V   | A        | 10       | 11.5     | 13       | 20 |    |    |
|  |  | 1200V   | A        | 7        | 8.5      | 10       | 10 |    |    |
|  |  | 1500V   | A        | 3        | 5        | 6        | 6  |    |    |
| 4 poles in series<br>4S, 4B, 4T<br> |  | 500V  | A        | 16       | 25       | 32       | 45 |    |    |
|  |  | 600V  | A        | 16       | 25       | 32       | 45 |    |    |
|  |  | 700V  | A        | 16       | 25       | 32       | 45 |    |    |
|  |  | 800V  | A        | 16       | 25       | 32       | 45 |    |    |
|  |  | 900V  | A        | 16       | 25       | 32       | 45 |    |    |
|  |  | 1000V   | A        | 16       | 25       | 32       | 38 |    |    |
|  |  | 1200V   | A        | 16       | 25       | 32       | 32 |    |    |
|  |  | 1500V   | A        | 16       | 20       | 32       | 32 |    |    |
| <b>Rated operational current <math>I_e</math></b>  |  |   |          |          |          |          |    |    |    |
| AC21B  | 2, 4   | $U_e$ max. 440V   | A        | 16       | 25       | 32       | 45 |    |    |
|  | 2H   | $U_e$ max. 440V   | A        | 29       | 45       | 50       | 50 |    |    |

1) Suitable at overvoltage category I to III, pollution degree 3 (standard-industry):  $U_{imp} = 8kV$ .

2) Suitable at overvoltage category I to III, pollution degree 2 (min.IP55):  $U_{imp} = 8kV$ .

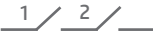
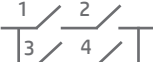
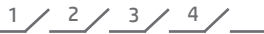

# Technical Data continued

Data according to IEC 60947-3, VDE 0660, GB14048.3

| Main Contacts  | Type              | SIM(E)16 |    | SIM(E)25 |      | SIM(E)32 |     | SIM(E)38 |    |    |  |
|--|-------------------|----------|----|----------|------|----------|-----|----------|----|----|--|
| Rated operational current I <sub>e</sub>   | 300V              | A        | 16 | 16       | 23   | 23       | 27  | 27       | -  | 27 |  |
|  | 400V              | A        | 14 | 14       | 22   | 18       | 25  | 20       | -  | 20 |  |
| DC-PV1<br>1 pole<br>1  | 500V              | A        | 10 | 10       | 17   | 12       | 20  | 14       | -  | 14 |  |
|  | 600V              | A        | 7  | 5        | 12   | 6        | 15  | 8        | -  | 8  |  |
|  | 700V              | A        | 5  | 1.5      | 6    | 2        | 7.5 | 3        | -  | 3  |  |
|  | 800V              | A        | 3  | 1.5      | 4    | 2        | 5   | 3        | -  | 3  |  |
| DC-PV2<br>1 pole<br>                              | 900V              | A        | 3  | 1        | 3    | 1.5      | 4   | 2        | -  | 2  |  |
|  | 1000V             | A        | 2  | 1        | 2    | 1.5      | 3   | 2        | -  | 2  |  |
|  | 2 poles in series |          |    |          |      |          |     |          |    |    |  |
|  | 500V              | A        | 16 | 16       | 25   | 25       | 32  | 32       | 45 | 38 |  |
| 2<br>   | 600V              | A        | 16 | 14       | 25   | 21       | 32  | 27       | 45 | 31 |  |
|  | 700V              | A        | 16 | 13       | 25   | 19       | 32  | 22       | 36 | 25 |  |
|  | 800V              | A        | 16 | 12       | 20   | 15       | 23  | 17       | 30 | 19 |  |
|  | 900V              | A        | 16 | 8        | 17   | 10       | 20  | 12       | 25 | 14 |  |
|  | 1000V             | A        | 10 | 4        | 11.5 | 5        | 13  | 6        | 20 | 7  |  |
|  | 1100V             | A        | 8  | 3        | 10   | 4        | -   | -        | -  | -  |  |
|  | 1200V             | A        | 7  | 2        | 8.5  | 3        | 10  | 4        | 10 | 4  |  |
|  | 1300V             | A        | 6  | 1.5      | 7    | 2        | -   | -        | -  | -  |  |
|  | 1400V             | A        | 5  | 1        | 6    | 2        | -   | -        | -  | -  |  |
|  | 1500V             | A        | 3  | 1        | 5    | 1.5      | 6   | 2        | 6  | 2  |  |
| 2 poles in series<br>+ 2 poles parallel<br>2H<br> | 500V              | A        | 29 | 25       | 45   | 39       | 50  | 50       | 50 | 50 |  |
|  | 600V              | A        | 29 | 20       | 36   | 32       | 50  | 35       | 50 | 38 |  |
|  | 700V              | A        | 22 | 13       | 27   | 19       | 32  | 22       | 36 | 25 |  |
|  | 800V              | A        | 17 | 12       | 20   | 15       | 23  | 17       | 30 | 19 |  |
|  | 900V              | A        | 16 | 8        | 17   | 10       | 20  | 12       | 25 | 14 |  |
|  | 1000V             | A        | 10 | 4        | 11.5 | 5        | 13  | 6        | 20 | 7  |  |
|  | 1100V             | A        | 8  | 3        | 10   | 4        | -   | -        | -  | -  |  |
|  | 1200V             | A        | 7  | 2        | 8.5  | 3        | 10  | 4        | 10 | 4  |  |
|  | 1300V             | A        | 6  | 1.5      | 7    | 2        | -   | -        | -  | -  |  |
|  | 1400V             | A        | 5  | 1        | 6    | 2        | -   | -        | -  | -  |  |
| 1500V  | A                 | 3        | 1  | 5        | 1.5  | 6        | 2   | 6        | 2  |    |  |
| 4 poles in series<br>4S, 4B, 4T<br>             | 500V              | A        | 16 | 16       | 25   | 25       | 32  | 32       | 45 | 45 |  |
|  | 600V              | A        | 16 | 16       | 25   | 25       | 32  | 32       | 45 | 45 |  |
|  | 700V              | A        | 16 | 16       | 25   | 25       | 32  | 32       | 45 | 45 |  |
|  | 800V              | A        | 16 | 16       | 25   | 25       | 32  | 32       | 45 | 38 |  |
|  | 900V              | A        | 16 | 16       | 25   | 25       | 32  | 32       | 45 | 38 |  |
|  | 1000V             | A        | 16 | 16       | 25   | 25       | 32  | 32       | 38 | 38 |  |
|  | 1100V             | A        | 16 | 16       | 25   | 25       | -   | -        | -  | -  |  |
|  | 1200V             | A        | 16 | 13.5     | 25   | 21       | 32  | 27       | 32 | 27 |  |
|  | 1300V             | A        | 16 | 12       | 25   | 19       | -   | -        | -  | -  |  |
|  | 1400V             | A        | 16 | 10.5     | 25   | 16       | -   | -        | -  | -  |  |
| 1500V  | A                 | 16       | 9  | 25       | 14   | 32       | 18  | 32       | 18 |    |  |
| 4 poles in series + 2 parallel<br>4H<br>        | 500V              | A        | 29 | 29       | 45   | 45       | 50  | 50       | 50 | 50 |  |
|  | 600V              | A        | 29 | 29       | 45   | 45       | 50  | 50       | 50 | 50 |  |
|  | 700V              | A        | 29 | 25       | 45   | 40       | 50  | 50       | 50 | 50 |  |
|  | 800V              | A        | 29 | 21       | 45   | 35       | 50  | 45       | 50 | 50 |  |
|  | 900V              | A        | 29 | 18       | 45   | 30       | 50  | 37       | 50 | 50 |  |
|  | 1000V             | A        | 29 | 16       | 45   | 25       | 50  | 32       | 50 | 50 |  |
|  | 1100V             | A        | 29 | -        | -    | -        | -   | -        | -  | -  |  |
|  | 1200V             | A        | 29 | 13.5     | 33   | 21       | 50  | 27       | 50 | 27 |  |
|  | 1300V             | A        | 29 | -        | -    | -        | -   | -        | -  | -  |  |
|  | 1400V             | A        | 29 | -        | -    | -        | -   | -        | -  | -  |  |
| 1500V  | A                 | 20       | 9  | 26       | 14   | 32       | 18  | 32       | 18 |    |  |

# Technical Data continued

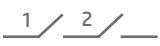
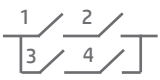
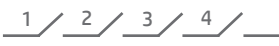
Data according to UL508i  File E362605, CCN: NMSJ and UL60947-1 & UL60947-4-1  File E146487, CCN: NRNT, NRNT7

| Main Contacts   | Type                       | SIM(E)16 | SIM(E)25 | SIM(E)32 | SIM(E)38 |
|---|----------------------------|----------|----------|----------|----------|
| <b>Ampere-Rating "General Use"</b>  |                            |          |          |          |          |
| DC  |                            |          |          |          |          |
| 1 pole  |                            |          |          |          |          |
| 1   | 350V A                     | 4        | 5        | 6        | 6        |
|   | 500V A                     | 4        | 5        | 6        | 6        |
|   | 600V A                     | 4        | 5        | 6        | 6        |
|    | 700V A                     | -        | -        | -        | -        |
|   | 800V A                     | -        | -        | -        | -        |
|   | 900V A                     | -        | -        | -        | -        |
|   | 1000V A                    | -        | -        | -        | -        |
| 2 poles in series   |                            |          |          |          |          |
| 2   | 350V A                     | 16       | 25       | 32       | 38       |
|   | 500V A                     | 16       | 25       | 32       | 38       |
|   | 600V A                     | 16       | 25       | 32       | 36       |
|    | 700V A                     | -        | -        | -        | -        |
|   | 800V A                     | -        | -        | -        | -        |
|   | 900V A                     | -        | -        | -        | -        |
|   | 1000V A                    | -        | -        | -        | -        |
| 2 poles in series + 2 poles parallel  |                            |          |          |          |          |
| 2H  | 350V A                     | 29       | 45       | 50       | 50       |
|   | 500V A                     | 29       | 38       | 43       | 45       |
|   | 600V A                     | 21       | 27       | 33       | 36       |
|    | 700V A                     | -        | -        | -        | -        |
|   | 800V A                     | -        | -        | -        | -        |
|   | 900V A                     | -        | -        | -        | -        |
|   | 1000V A                    | -        | -        | -        | -        |
| 4 poles in series   |                            |          |          |          |          |
| 4S, 4B, 4T  | 350V A                     | 16       | 25       | 32       | 38       |
|   | 500V A                     | 16       | 25       | 32       | 38       |
|   | 600V A                     | 16       | 25       | 32       | 36       |
|    | 700V A                     | 14       | 20       | 24.5     | 24.5     |
|   | 800V A                     | 12       | 16       | 19       | 19       |
|   | 900V A                     | -        | -        | -        | -        |
|   | 1000V A                    | -        | -        | -        | -        |
| 4 poles in series + 2 parallel  |                            |          |          |          |          |
| 4H  | 350V A                     | 16       | 25       | 50       | 50       |
|   | 500V A                     | 16       | 25       | 50       | 50       |
|   | 600V A                     | 16       | 25       | 50       | 50       |
|  | 700V A                     | -        | -        | -        | -        |
|   | 800V A                     | -        | -        | -        | -        |
|   | 900V A                     | -        | -        | -        | -        |
|   | 1000V A                    | -        | -        | -        | -        |
| Fuse size (RK5) Industrial Control Switch   |                            |          |          |          |          |
| 5kA / 600V  | A                          | 40       | 60       | 80       | 80       |
| <b>Maximum cable cross sections</b>   | (including jumper SIMV-B1) |          |          |          |          |
| solid   | AWG                        | 16 - 10  | 16 - 10  | 16 - 10  | 16 - 10  |
| stranded  | AWG                        | 20 - 6   | 20 - 6   | 20 - 6   | 20 - 6   |
| Size of terminal screw  |                            | M4 Pz1   | M4 Pz1   | M4 Pz1   | M4 Pz1   |
| Tightening torque   | lb.inch                    | 12.4     | 12.4     | 12.4     | 12.4     |

# Derating Curves for SIM16

Switch SIM(E)16 2 poles all types except PEL64R

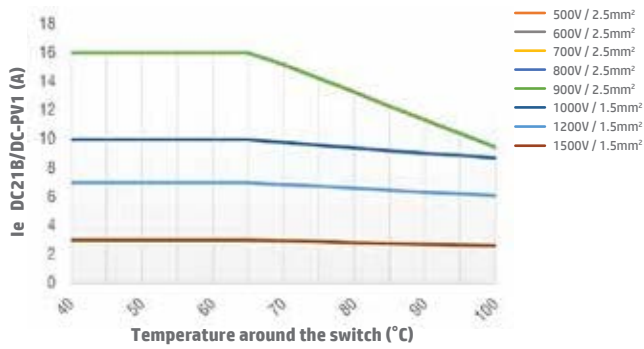

Switch SIM(E)16 2H all types except PEL64R

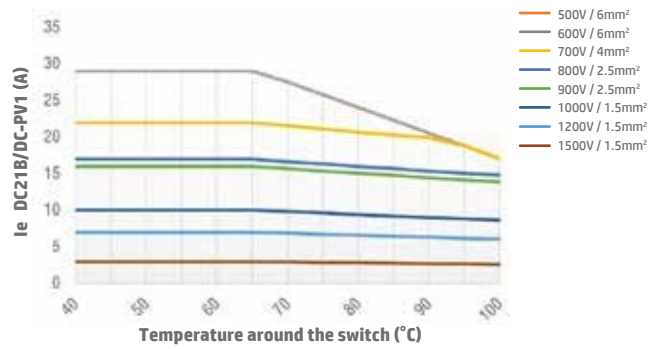

Switch SIM(E)16 4S/4B/4T all types except PEL64R

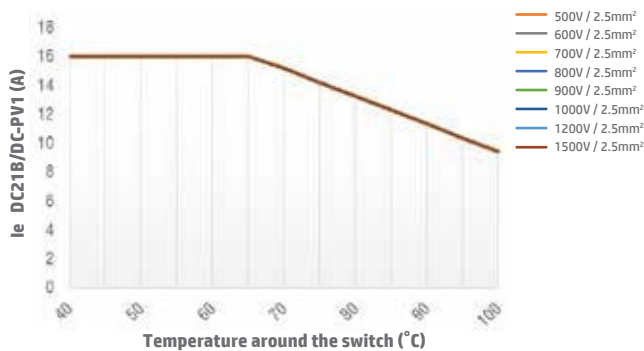

Switch SIM(E)16 2 poles PEL64R type

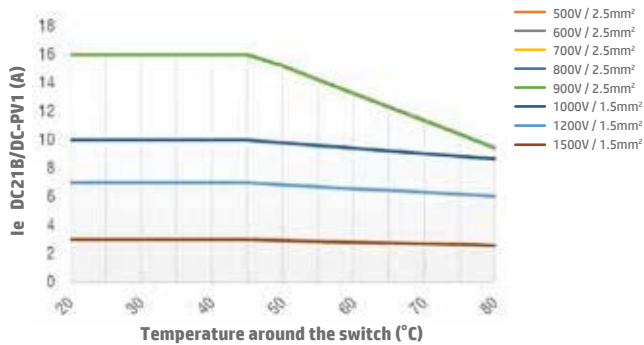

Switch SIM(E)16 2H PEL64R type

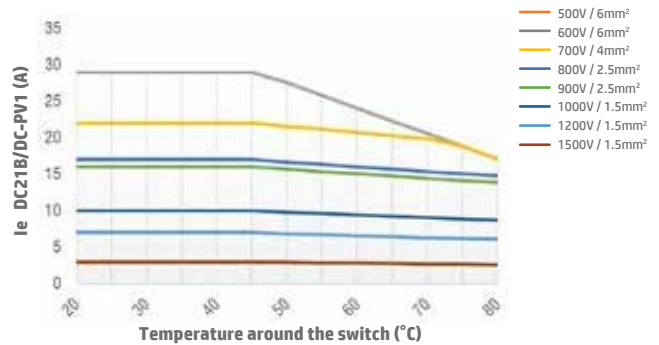

Switch SIM(E)16 4S/4B/4T PEL64R type

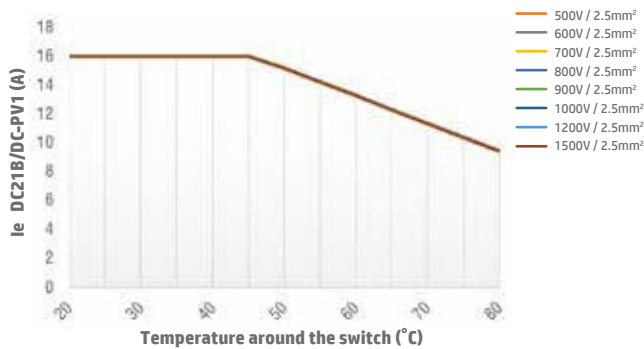

# Derating Curves for SIM25

Switch SIM(E)25 2 poles all types except PEL64R

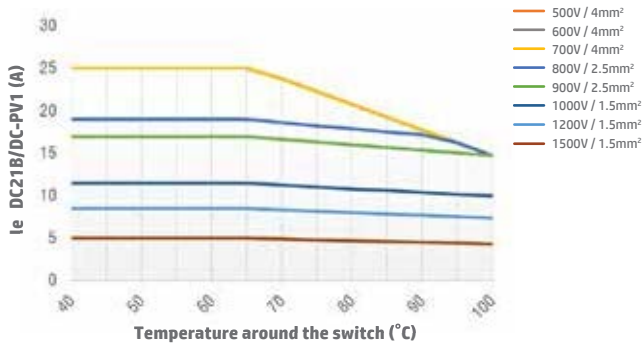

Switch SIM(E)25 2H all types except PEL64R

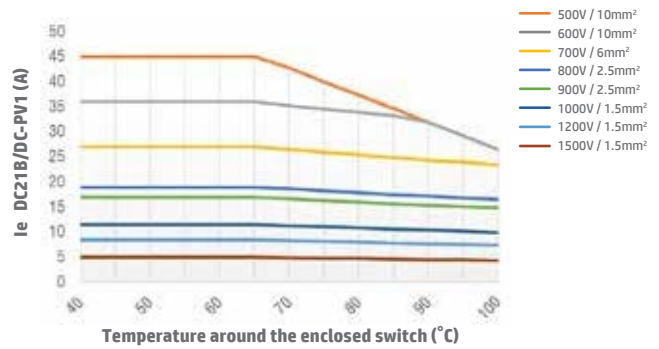

Switch SIM(E)25 4S/4B/4T all types except PEL64R

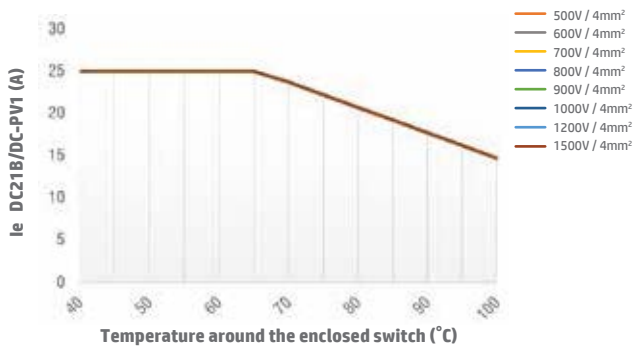

Switch SIM(E)25 2 poles PEL64R type

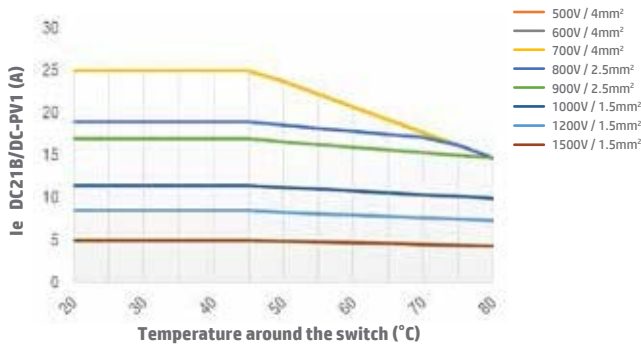

Switch SIM(E)25 2H PEL64R type

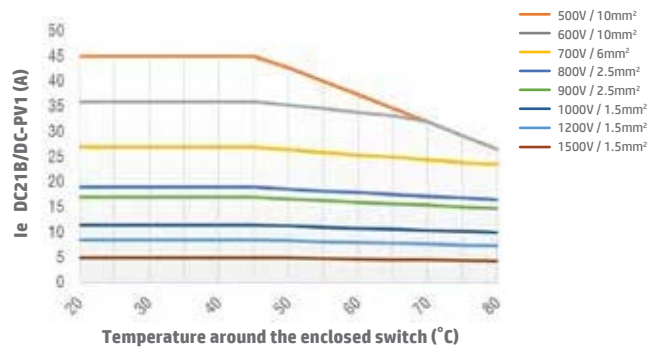

Switch SIM(E)25 4S/4B/4T PEL64R type

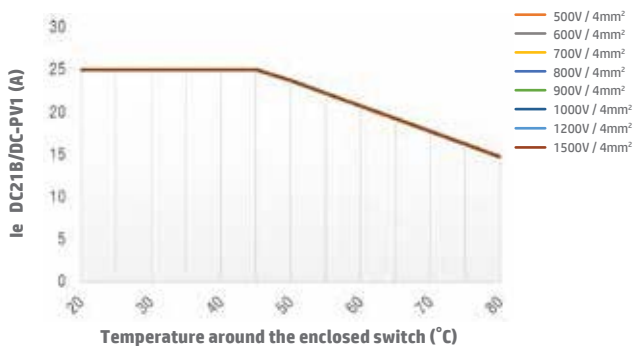

Note: SIM(E)32 & SIM(E)38 ratings available upon request

# Handle Options

## 48 x 48 Lever Handle



IP66 - NEMA 4X

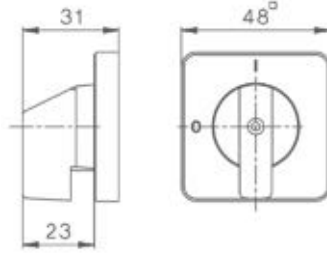

## Mounting Hole(s)

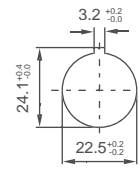

SHM Version

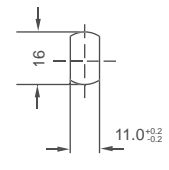

SHMS Version  
(No escutcheon plate)

## 48 x 48 Lever Handle with Lockable OFF



IP66 - NEMA 4X

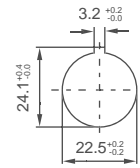
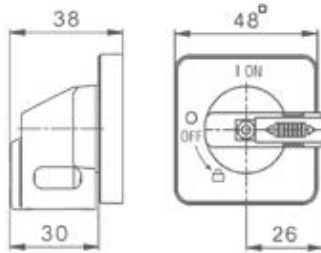

SHML Version

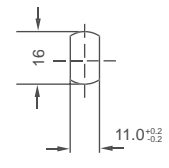

SHMSL Version  
(No escutcheon plate)

## 64 x 64 Lever Handle



IP66 - NEMA 3R

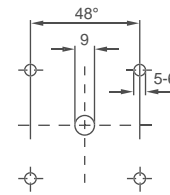
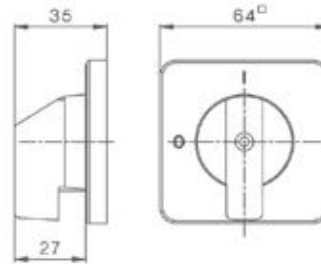

PM Version

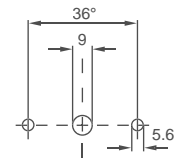

PMT Version

## 64 x 64 Lever Handle with Lockable OFF



IP66 - NEMA 3R

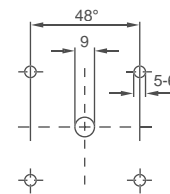
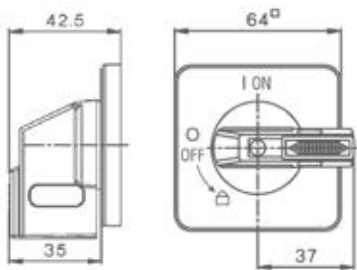

PM Version

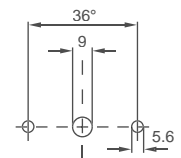

PMT Version

## 64 x 64 Rotary Handle with Lockable OFF



IP66 - NEMA 4X  
(PEL64R version - IP67)

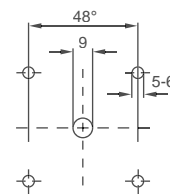
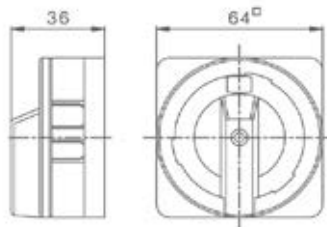

PM Version

Note: BMDC Version only requires central hole



## Dimensions (mm)

### Mounting Hole

**SIM\*\*-PM64-2**  
Panel Mounting  
64x64 Escutcheon Plate - 2 Pole

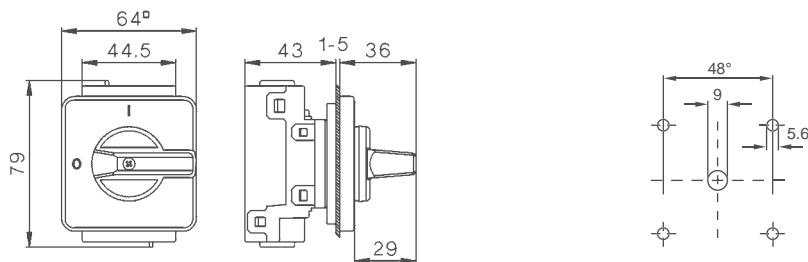

**SIM\*\*-PM64-4 / SIM\*\*-PM64-2H**  
Panel Mounting  
64x64 Escutcheon Plate - 4 Pole

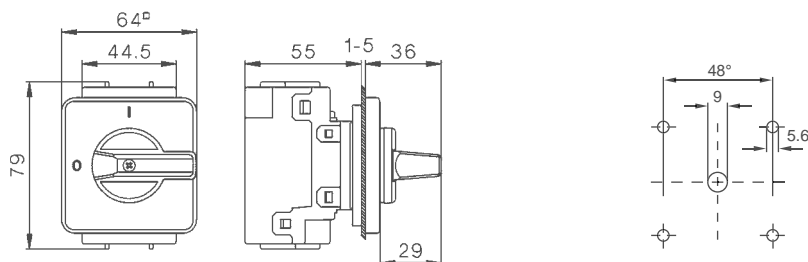

**SIM\*\*-PMT64-2**  
Panel Mounting  
64x64 Escutcheon Plate - 2 Pole

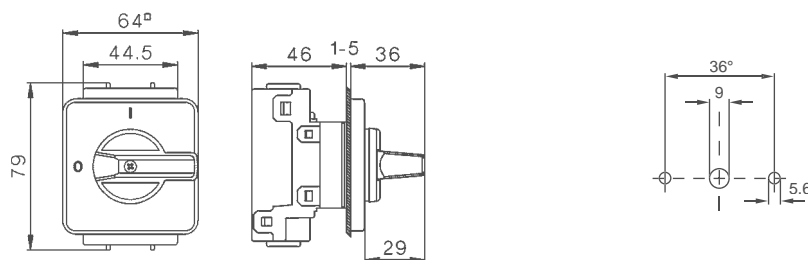

**SIM\*\*-PMT64-4 / SIM\*\*-PMT64-2H**  
Panel Mounting  
64x64 Escutcheon Plate - 4 Pole

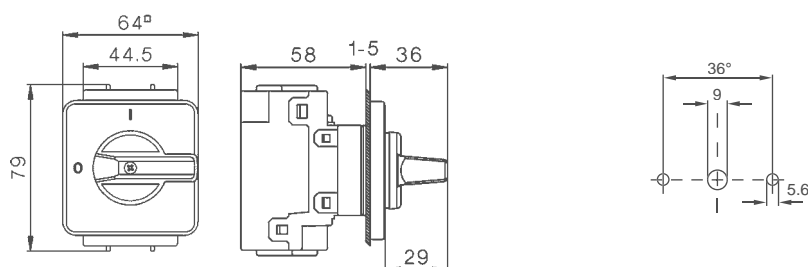

**SIM\*\*-SHM-2**  
Single Hole Mounting  
Ø 22.5mm - 2 Pole

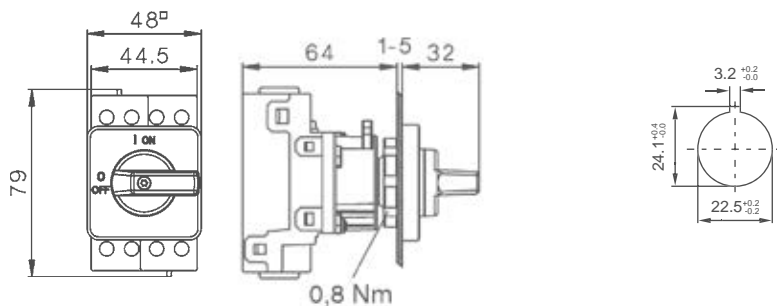

Mounting Hole

**SIM\*\*-SHM-4 / SIM\*\*-SHM-2H**

Single Hole Mounting  
 Ø 22.5mm - 4 Pole

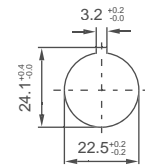
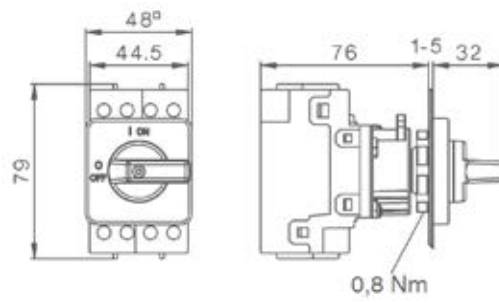

**SIM\*\*-SHMS-2**

Single Hole Mounting  
 Ø 16mm - 2 Pole

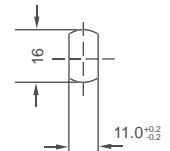
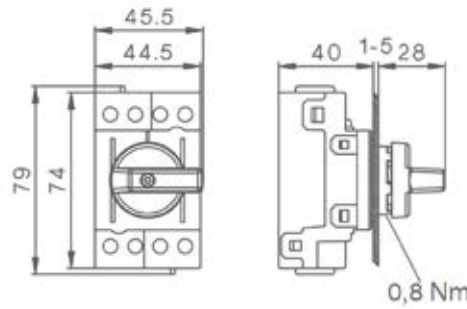

**SIM\*\*-SHMS-4 / SIM\*\*-SHMS-2H**

Single Hole Mounting  
 Ø 16mm - 4 Pole

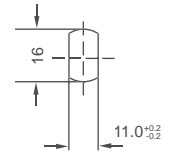
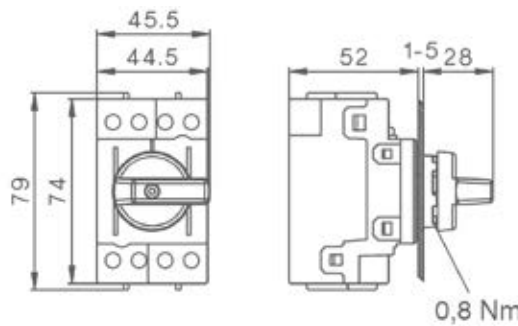

**SIM\*\*-BMDC64R-2**

Base Mounting with door coupling  
 64x64 Escutcheon Plate - 2 Pole

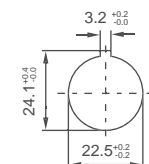
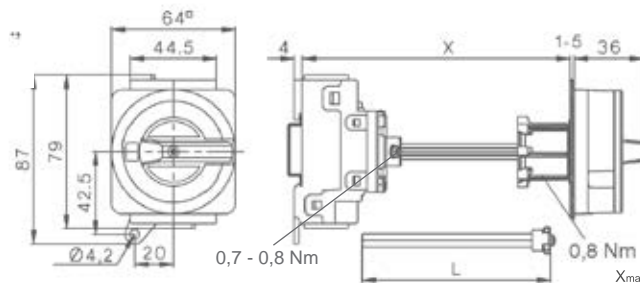

$X_{max} = 182$   
 $L = X - 26.5 (\pm 3)$

**SIM\*\*-BMDC64R-4 / SIM\*\*-BMDC64R-2H**

Base Mounting with door coupling  
 64x64 Escutcheon Plate - 4 Pole

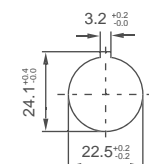
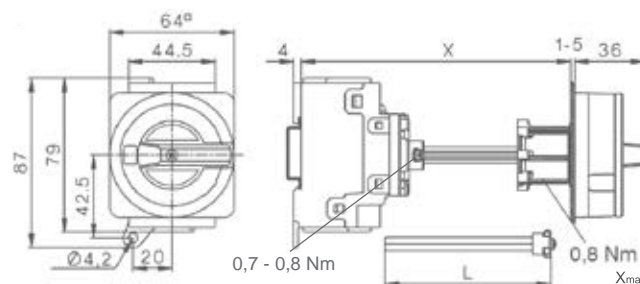

$X_{max} = 194$   
 $L = X - 38.5 (\pm 3)$

**SIM\*\*-BMS64R-4 / SIM\*\*-BMS64R-2H**

Base Mounting with 2 mounting lugs  
 64x64 Escutcheon Plate - 4 Pole

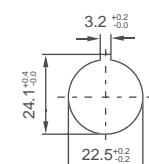
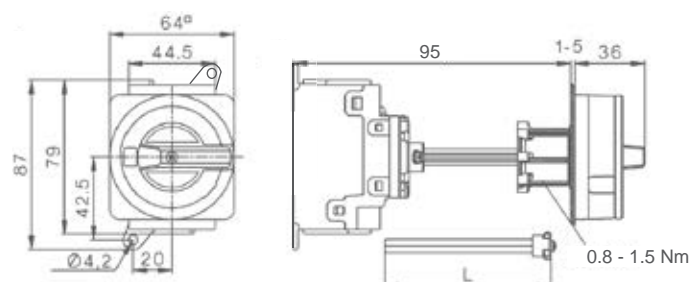

**SIM\*\*-DB-2**  
 Modular Switch  
 2 Pole

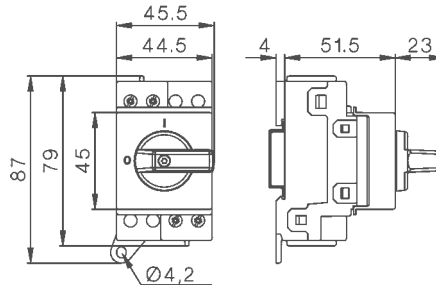

**SIM\*\*-DB-4 / SIM\*\*-DB-2H**  
 Modular Switch  
 4 Pole

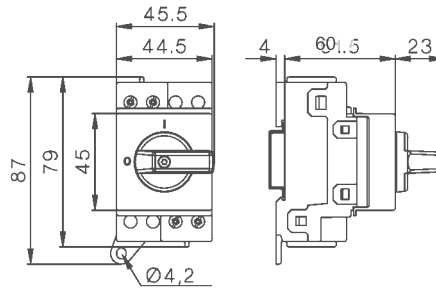

**SIM\*\*-DBL-2**  
 Lockable Modular Switch  
 2 Pole

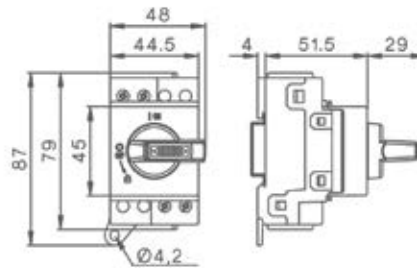

**SIM\*\*-DBL-4 / SIM\*\*-DBL-2H**  
 Lockable Modular Switch  
 4 Pole

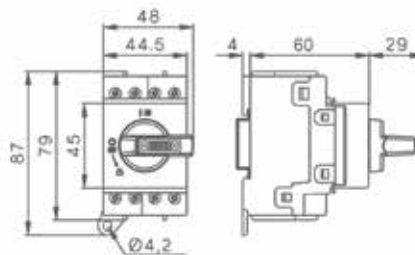

**SIM\*\*-PEL64R-\***  
 Plastic Enclosure

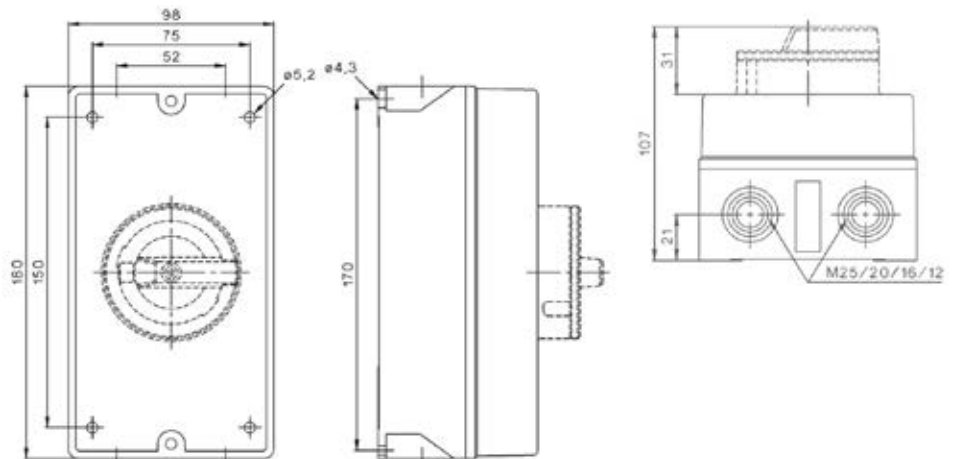

# DC Isolator Distribution/String Boxes

- 4 to 48 poles
- High thermal stability - ASA plastic
- Transparent door
- UV stabilized
- IP65 rating - Inside / Outside use
- Earth & neutral bars included
- Suitable for Photovoltaic applications
- Optional Key Lock (E-Lock)



## Technical Data

|                  |      |                   |               |
|------------------|------|-------------------|---------------|
| Protection class | IP65 | Temperature range | -25°C to 60°C |
| Isolation class  | II   | Colour            | RAL 7035      |
| Impact kit       | IK07 | IEC capability    | 60670-25      |

| Type  | Description         | Number of terminals PE/N | Dimensions H x W x D (mm) |
|-------|---------------------|--------------------------|---------------------------|
| E-04W | 4 Module Enclosure  | 4/4                      | 201 x 128 x 120           |
| E-08W | 8 Module Enclosure  | 8/8                      | 201 x 202 x 120           |
| E-12W | 12 Module Enclosure | 10/10                    | 259 x 319 x 144           |
| E-24W | 24 Module Enclosure | 13/13                    | 384 x 319 x 144           |
| E-36W | 36 Module Enclosure | 15/15                    | 534 x 319 x 144           |
| E-48W | 48 Module Enclosure | 20/20                    | 664 x 319 x 141           |

| Type  | Cable Entries  |
|-------|--|
| E-04W | 4 x M20<br>4 x M25/M32   |
| E-08W | 8 x M20<br>6 x M25 /M32  |
| E-12W | 12 x M20<br>10 x M25/M32<br>4 x M32/M40<br>2 x side knockout 90 x 37mm |
| E-24W | 12 x M20<br>10 x M25/M32<br>4 x M32/M40<br>4 x side knockout 90 x 37mm |
| E-36W | 12 x M20<br>10 x M25/M32<br>4 x M32/M40<br>6 x side knockout 90 x 37mm |
| E-48W | 12 x M20<br>10 x M25/M32<br>4 x M32/M40<br>6 x side knockout 90 x 37mm |

### Step 1 - Select your box:



### Step 2 - Select your isolator:



### Step 3 - Select your accessories:

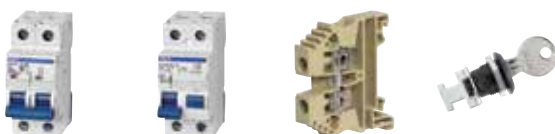

=



# Enclosed AC Isolators - PE69

- 3, 4, 6 and 8 pole versions available
- On load 20A - 100A
- Red/Yellow
- 3 Padlock positions
- IP65
- IP66 taller enclosure available
- Aux. Contacts available



| Part number | Number of poles | Rating @ 3~400V |        |           |         |
|-------------|-----------------|-----------------|--------|-----------|---------|
|             |                 | AC21/Amps       | AC3/kW | AC23/Amps | AC23/kW |
| PE69-3020   | 3               | 20              | 5.5    | 16        | 7.5     |
| PE69-3025   | 3               | 25              | 7.5    | 20        | 10      |
| PE69-3032   | 3               | 32              | 11     | 25        | 12.5    |
| PE69-3040   | 3               | 40              | 15     | 32        | 16      |
| PE69-3063   | 3               | 63              | 18.5   | 45        | 22      |
| PE69-3080   | 3               | 80              | 18.5   | 45        | 22      |
| PE69-30100  | 3               | 100             | 30     | 72        | 37      |
| PE69-4020   | 4               | 20              | 5.5    | 16        | 7.5     |
| PE69-4025   | 4               | 25              | 7.5    | 20        | 10      |
| PE69-4032   | 4               | 32              | 11     | 25        | 12.5    |
| PE69-4040   | 4               | 40              | 15     | 32        | 16      |
| PE69-4063   | 4               | 63              | 18.5   | 45        | 22      |
| PE69-4080   | 4               | 80              | 18.5   | 45        | 22      |
| PE69-40100  | 4               | 100             | 30     | 72        | 37      |
| PE69-6020   | 6               | 20              | 5.5    | 16        | 7.5     |
| PE69-6025   | 6               | 25              | 7.5    | 20        | 10      |
| PE69-6032   | 6               | 32              | 11     | 25        | 12.5    |
| PE69-6060   | 6               | 40              | 15     | 32        | 16      |
| PE69-6063   | 6               | 63              | 18.5   | 45        | 22      |
| PE69-6080   | 6               | 80              | 18.5   | 45        | 22      |
| PE69-8020   | 8               | 20              | 5.5    | 16        | 7.5     |
| PE69-8025   | 8               | 25              | 7.5    | 20        | 10      |
| PE69-8032   | 8               | 32              | 11     | 25        | 12.5    |
| PE69-8080   | 8               | 40              | 15     | 32        | 16      |
| PE69-8063   | 8               | 63              | 18.5   | 45        | 22      |
| PE69-8080   | 8               | 80              | 18.5   | 45        | 22      |

## Dimensions (mm)

| Type         | Pole | A   | B   | C     | D1               | E   | F   | H   |
|--------------|------|-----|-----|-------|------------------|-----|-----|-----|
| PE69..20-40  | 3, 4 | 130 | 98  | 120   | 2x25.5/20,5      | 75  | 150 | 76  |
| PE69..63-100 | 3, 4 | 200 | 140 | 188.5 | 40.5/32.5 + 16.5 | 100 | 160 | 86  |
| PE69..20-40  | 6    | 200 | 140 | 188.5 | 40.5/32.5 + 16.5 | 100 | 160 | 86  |
| PE69..20-40  | 8    | 240 | 176 | 228.5 | 40.5/32.5        | 120 | 200 | 120 |
| PE69..63-80  | 6, 8 | 240 | 176 | 228.5 | 40.5/32.5        | 120 | 200 | 120 |

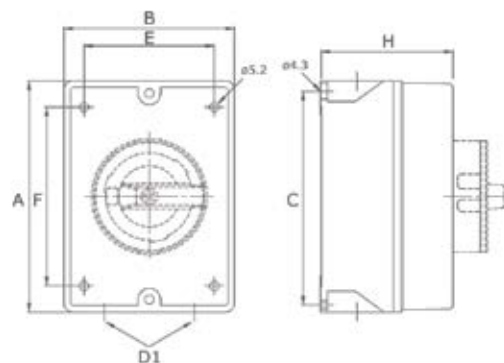

# FireRaptor Solar Panel Rapid Shutdown

- Manual Panel Shutdown to 0V Operated from Ground Level
- Automatic Panel Shutdown to 0V at >85°C (185°F) Temperature
- Automatic Panel Shutdown to 0V on External Power Loss
- Hardwire or Mobile Communication Alarm Signalling
- Compliant with NEC 2017 and NEC 2020
- Suitable for New Installations or Retro-Fit



## FireRaptor Overview

The IMO FireRaptor provides three forms of Solar Panel Rapid Shutdown to ZERO VOLTS in case of fire or other emergency:

### • MANUAL EMERGENCY SHUTDOWN

Manual shutdown is operated via an Emergency Rapid Shutdown Switch utilising a typical “one push” large emergency push button. The switch can be conveniently located anywhere for emergency access and is supplied with a 24VDC power supply to interface with the FireRaptor units.

### • AUTOMATIC EMERGENCY TEMPERATURE SHUTDOWN

Automatic shutdown occurs via the temperature sensor onboard the FireRaptor detecting an ambient temperature rise in excess of 85°C (185°F). In the event that the temperature exceeds 85°C (185°F) the FireRaptor will act to shut-down the PV panels as follows:-

**FRS-01** - Shuts down the panels connected to the individual FireRaptor sensing the temperature rise above 85°C (185°F). The FireRaptor will re-engage the panels if the temperature drops back below 85°C (185°F) provided it does not exceed 92°C (198°F), in which case a manual reset of the Emergency Switch is required.

**FRS-02** - Shuts down the entire string in which the individual FireRaptor sensing the temperature rise above 92°C (198°F) is connected. If this occurs a signal is sent to the Emergency Switch and resetting of the Emergency Switch is then required by a professional installer. The Emergency Switch can be configured to provide connection to the building’s central alarm system or notification via mobile communication (SMS, email etc.).

### • AUTOMATIC EMERGENCY EXTERNAL POWER LOSS SHUTDOWN

Disconnection of the external AC supply, by whatever means, causes automatic remote operation of the Emergency Rapid Shutdown Switch.

The FireRaptor can be installed without any set-up and with any string inverter as its functionality is completely independent. “Plug & Play” style installation using industry standard connectors is easy, whether fitted to new installs or retro-fitted to existing projects to upgrade fire safety functionality.

The FireRaptor meets the current requirements of



## Ordering Information

| Part Number     | Description  |
|-----------------|--|
| FRS-01          | FireRaptor Rapid Shutdown Unit - suitable for connection to two solar panels                         |
| FRS-02          | FireRaptor Monitored Rapid Shutdown Unit - suitable for connection to two solar panels               |
| FRS-ESW1        | Emergency Rapid Shutdown Switch IP66 (for FRS-01) - includes 24VDC power supply                      |
| FRS-ESW1-K      | Emergency Rapid Shutdown Switch IP66 (for FRS-01) with Key Lock - includes 24VDC power supply        |
| FRS-ESW2        | Emergency Rapid Shutdown Switch IP66 (for FRS-02) - includes 24VDC power supply                      |
| FRS-ESW2-K      | Emergency Rapid Shutdown Switch IP66 (for FRS-02) with Key Lock - includes 24VDC power supply        |
| FRS-SIGCAB1.8-F | 1.8m (70”) Signal Cable terminated at one end with Tyco female connector for use at end of PV String |

## Emergency Shutdown Switch

The Emergency Shutdown Switch for both the FRS-01 and the FRS-02 is supplied with a 24VDC power supply suitable for up to 40 panel operation. It is available with either a “twist-to-release” pushbutton or keylock pushbutton, both with LED indicator to signal FireRaptor supply status (ON indicates the supply is live).

For larger installations, the Emergency Shutdown Switch is available in custom format with:

- Larger power supply options for increased number of panels (FRS-01 & FRS-02)
- Multi connection terminals for increased number of strings (FRS-01 & FRS-02)
- Temperature monitoring unit with hardwire or mobile communication alarm signalling (FRS-02)

Contact IMO for further information on any of these options.



## Technical Specification

|  |  |
|--|--|
| <b>Shutdown Control Cable</b>            | 2x1mm <sup>2</sup> cable + Tyco SuperSeal 2-pole connector   |
| <b>Panel &amp; String Cable</b>          | 4mm <sup>2</sup> DC rated cable + MC4 type connector   |
| <b>DC Power Supply</b>                   | 24VDC suitable for up to 20 FireRaptor units (40 panels) - Input 90-264VAC                                     |
| <b>Maximum Input Power</b>               | 700W (350W per panel)  |
| <b>Maximum Input Voltage</b>             | 150V (75V per panel)   |
| <b>Maximum Input Current</b>             | 12A  |
| <b>Maximum System Voltage</b>            | 1500V  |
| <b>Input Protection</b>                  | Over voltage & transient voltage suppression   |
| <b>Maximum Output Current</b>            | 12A (99.5% efficiency)   |
| <b>Dielectric Strength</b>               | 1500VAC for 1 minute   |
| <b>Maximum Output Voltage</b>            | 150V (75V per panel)   |
| <b>Output Protection</b>                 | Over voltage, over current & transient voltage suppression   |
| <b>Ambient Operating Temperature</b>     | -30°C (-22°F) to +95°C (203°F)   |
| <b>IP Class Protection</b>               | FireRaptor - IP68 (designed to comply with NEMA 4X), Emergency Switch - IP66 (designed to comply with NEMA 3R) |
| <b>Casing</b>                            | FireRaptor - Flame retardant Polycarbonate - UL94-V0, Emergency Switch - Flame retardant ABS - UL94-HB         |
| <b>Weight (without cables)</b>           | 300g (10.6oz.)   |
| <b>Panel Cable Length</b>                | 120mm (4 <sup>1</sup> / <sub>16</sub> "")  |
| <b>String &amp; Control Cable Length</b> | 1800mm (70 <sup>7</sup> / <sub>8</sub> "")   |
| <b>Standard Compliance</b>               | EN61000, EN61646, EN61215, IEC 62716 draft C (NH <sub>3</sub> resistant), VDE-AR-E 2100-712, BS7671-712        |

## Dimensions (mm)

Tolerance ±0.5mm

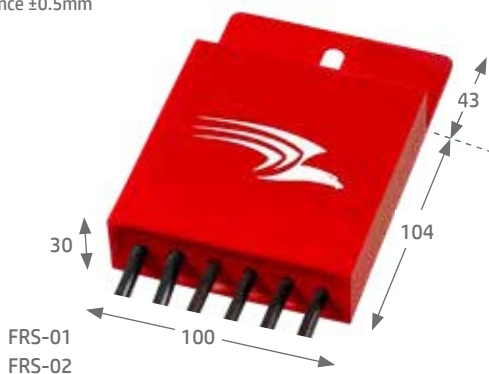

# Solar Tracking & Measurement Controller

- Out-of-the-box solution
- Easy to set up
- Flexibility to adapt to any installation



## Solar Cube Overview

The IMO Solar Cube has been developed as a ground breaking, easy to set up solar tracking and measurement controller with the flexibility to adapt to any installation.

The Solar Cube is an off the shelf controller designed for use on either one or two axis solar panel installations to track the sun's movement and provide optimum panel (or array) positioning. The sun's position is calculated using the local time and date comparing this with the longitude and latitude location of the solar array. From this data the Solar Cube calculates the 'zenith angle' and the 'azimuth angle', which together exactly specify the position of the sun in the sky to within 0.01°.

To position the array the Solar Cube uses feedback from an electronic compass device connected via RS232 or RS485 which then activates the solar array's actuators until the correct position is reached. The compass is mounted directly on the array frame to give accurate positioning information.

With the option of GPS positioning or manual inputting of the array's location, the Solar Cube is easy to setup anywhere in the world. The Solar Cube is a competitive solution for controlling each array or it can be configured to control up to 4 arrays from one controller providing additional savings. Options for feedback and control from a single control station or via a web server are also available.

Solar Cube also offers data logging facilities using its own internal Micro SD card. Power output can be logged continually to produce daily, monthly and yearly figures. Revenues can be calculated along with CO<sub>2</sub> reduction figures.

## Exact Solar Tracking

The sun's position calculation depends upon the current time and date as well as longitude and latitude location of the solar array. The results of this calculation are the 'zenith angle' and the 'azimuth angle', which together exactly specify the position of the sun in the sky.

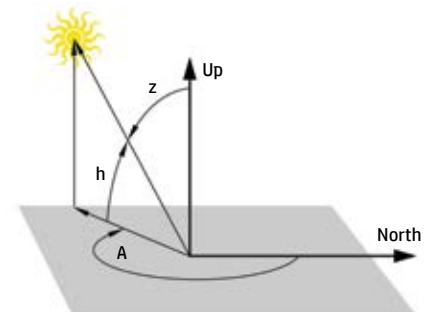

h - elevation angle, measured up from the horizon

z - zenith angle, measured from vertical

A - azimuth angle, measured clockwise from north

## Data Logging Facility

Solar Cube also offers data logging facilities using its own internal MicroSD card. Power output can be logged continually to produce daily, monthly and annual figures. Revenues can be calculated along with CO<sub>2</sub> avoidance figures.



Create MS Excel compatible files, backup/restore user programs and change recipe templates.

Access the data remotely using IMO i3-Transfer software. Copy, paste and delete files through Serial or GSM connections, or through the IMO iConnect.

Automate the file transfer process through powerful scripting.



## Solar Cube Key Features

- 3.5" Monochrome Touch Screen
- 5 Pre-programmed function keys
- Built-in sun positioning algorithm
- 3D Compass input for accurate positioning
- Automatic location and clock updates with GPS
- MicroSD card for data logging
- Password security for all settings
- Error based adjustment with configurable error values for each axis
- Configurable minimum and maximum adjustment angles
- Configurable safety cut-out system
- Configurable twilight settings (returns to morning position automatically)
- Single Axis supports Azimuth or Zenith tracking
- Supports custom inverter serial communications
- GPRS and Ethernet Remote Access options available
- Emergency Stop input
- Manual Jog function
- Manual Override key
- Optional Ice and Wind Sensor inputs
- Four motor outputs (For 2 Axis Control)
- Limit Switch inputs for safety cut out
- Optional Washer Control output
- Analog input for power output measurement (CT Connection)
- Optional analog input for light level sensing
- IP65 (NEMA4) CE, cUL, UL
- 10-30VDC supply

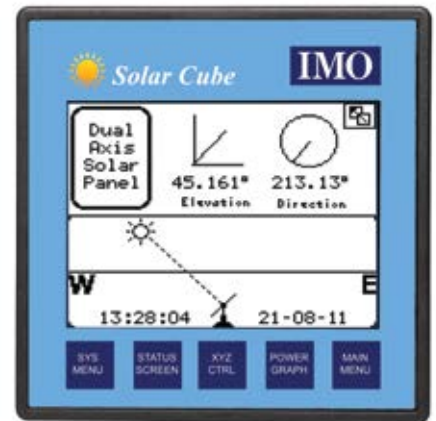
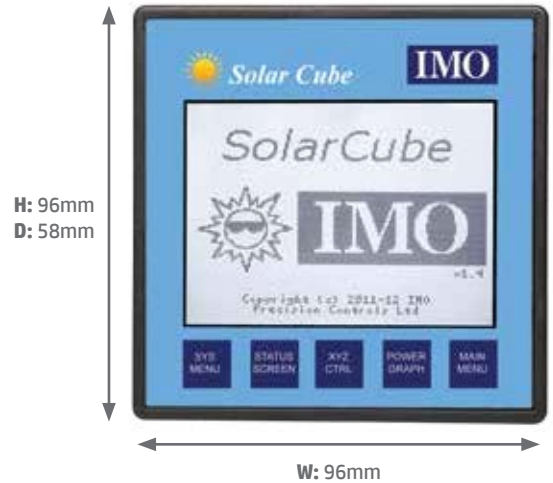

## Solar Cube Data Logging

- Total kWh produced to date
- Total kWh produced today
- Current Power Output graph (kW against time)
- Yesterday's Power Output graph
- Yield Values for last 31 days (kWh against days)
- Yield Values for last 12 months (kWh against months)
- Specific Annual Yield

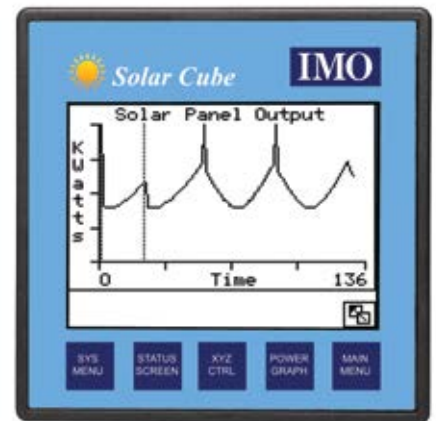

## Ordering Information

### Single Array

| Part Number      | Description  |
|------------------|--|
| SOLARCUBE-1A     | Single Array Solar Tracker, 1 or 2 axis configurable |
| COMPASS-485      | 3D Positional Compass                                |
| OEM GPS RECEIVER | RS232 GPS Receiver                                   |



### Four Array



| Part Number        | Description  |
|--------------------|--|
| SOLARCUBE-4A       | Four Array Solar Tracker, 1 or 2 axis configurable |
| SMT-CD-R20-V3 (x3) | Slave Array I/O Repeater                           |
| COMPASS-485 (x4)   | 3D Positional Compass                              |
| OEM GPS RECEIVER   | RS232 GPS Receiver                                 |

**Note:** Above configuration can be used for each group of 4 Arrays. Where a large number of Arrays need linking a Master Control option is available, call IMO for details.

# Solar Relays



| Model                       | DYA  | PHY   | PEY  |
|-----------------------------|--|---|--|
|                             |   |   |   |
| Features                    | <ul style="list-style-type: none"> <li>- High voltage direct current relay</li> <li>- 10A, 20A, 40A, 80A, 120A, 200A, 300A switch capability</li> <li>- 10A, 20A, 40A: No specific polarity requirements for connection</li> <li>- Switching power up to 750kW</li> <li>- 2.5kV dielectric strength (between coil &amp; contacts)</li> </ul> | <ul style="list-style-type: none"> <li>- 30A switching capability</li> <li>- 4kV dielectric strength</li> <li>- Class F insulation</li> <li>- 3.00mm contact gap</li> </ul> | <ul style="list-style-type: none"> <li>- 30A switching capability</li> <li>- 4kV dielectric strength</li> <li>- Class F insulation</li> <li>- 3.0mm contact gap</li> </ul> |
| Contact Form                | 1A   | 1A, 2A  | 1A, 2A   |
| Contact Material            | Alloy  | AgSnO <sub>2</sub>  | AgSnO <sub>2</sub>   |
| Max. Switching Voltage      | 750VDC   | 277VAC  | 277VAC   |
| Max. Switching Power        | 30-750kW   | 8310VA / 6925VA   | 8310VA / 6925VA  |
| Rated Load (Resistive Load) | 10A 450VDC - 300A 450VDC   | 1A: 30A 240VAC/30A 277VAC<br>2A: 25A 240VAC/25A 277VAC  | 1A: 30A 240VAC/30A 277VAC<br>2A: 25A 240VAC/25A 277VAC   |
| Rated Voltage               | 12, 24VDC  | 6 to 220/240VAC, 3 to 200VDC  | 6 to 220/240VAC, 3 to 200VDC   |
| Ambient Temperature         | -40°C to + 85°C  | -55°C to + 70°C   | -55°C to + 70°C  |
| Mechanical Life (min.)      | 2 x 10 <sup>5</sup> ops  | 1 x 10 <sup>7</sup> ops   | 1 x 10 <sup>7</sup> ops  |
| Electric Life (min.)        | Product Dependant  | 1 x 10 <sup>5</sup> ops   | 1 x 10 <sup>5</sup> ops  |
| Terminal Type               | QC, Screw  | PCB, QC   | Screw  |

| Model                       | PRW   | PRR  | PQY   |
|-----------------------------|---|--|---|
|                             |    |    |    |
| Features                    | <ul style="list-style-type: none"> <li>- 31A switching capability</li> <li>- Applicable to inverter used for photovoltaic power generation systems</li> <li>- Ideal for UPS</li> <li>- 1.5mm contact gap</li> <li>- Clearance between contact &amp; coil is greater than 6.4mm</li> <li>- Creepage distance &gt; 8mm</li> </ul> | <ul style="list-style-type: none"> <li>- 10A switching capability</li> <li>- 5kV dielectric strength</li> <li>- 1.5mm contact gap</li> <li>- Sealed and dust protected versions available</li> </ul> | <ul style="list-style-type: none"> <li>- 10A switching capability</li> <li>- 1.5kV dielectric strength</li> <li>- 2.00mm contact gap</li> <li>- Plug-in and PCB versions available</li> </ul> |
| Contact Form                | 1A  | 2A   | 2C  |
| Contact Material            | AgSnO <sub>2</sub>  | AgSnO <sub>2</sub>   | AgCe  |
| Max. Switching Voltage      | 277VAC  | 30VDC / 250VAC   | 30VDC / 250VAC  |
| Max. Switching Power        | 7750VA  | 240W / 2500VA  | 300W / 2500VA   |
| Rated Load (Resistive Load) | Resistive: 26A 250VAC<br>Inductive: 31A 250VAC  | 10A 250VAC / 8A 30VDC  | 10A 30VDC / 250VAC  |
| Rated Voltage               | 9 to 24VDC  | 3 to 60VDC   | 6 to 240VAC, 5 to 220VDC  |
| Ambient Temperature         | -40°C to + 85°C   | -40°C to + 85°C  | -40°C to + 70°C   |
| Mechanical Life (min.)      | 1 x 10 <sup>6</sup> ops   | 5 x 10 <sup>5</sup> ops  | 1 x 10 <sup>7</sup> ops   |
| Electric Life (min.)        | 3 x 10 <sup>4</sup> ops   | 1 x 10 <sup>5</sup> ops  | 1 x 10 <sup>5</sup> ops   |
| Terminal Type               | PCB, QC   | PCB  | PCB, QC   |

# PV Rated DIN Rail Terminals

- 1000V Rated up to 232A
- Up to 95mm<sup>2</sup> wiring capacity
- UL94-V0 Materials
- Various colours available
- Labelling options
- UR/cUR approved (E244285)



| General Product Information        | ER16V               | ER35PV              | ER50V                                | ER70V                                | ER70PV                               |
|------------------------------------|---------------------|---------------------|--------------------------------------|--------------------------------------|--------------------------------------|
| Insulating material                | PA 66               | PA 66               | PA 66                                | PA 66                                | PA 66                                |
| Inflammability class acc. to UL 94 | V0                  | V0                  | V0                                   | V0                                   | V0                                   |
| <b>Dimensions</b>                  |                     |                     |                                      |                                      |                                      |
| Width                              | 12 mm               | 16 mm               | 20 mm                                | 22 mm                                | 22 mm                                |
| Length                             | 50 mm               | 52.8 mm             | 80 mm                                | 74.0 mm                              | 80.0 mm                              |
| Height (MR 35x7,5)                 | 55.5mm              | 58.7 mm             | 84.7mm                               | 67.5 mm                              | 88.7 mm                              |
| <b>IEC Technical Data</b>          |                     |                     |                                      |                                      |                                      |
| Nominal Voltage                    | 1000 V              | 1000 V              | 1000 V                               | 750 V                                | 1000 V                               |
| Nominal Current                    | 76 A                | 115 A               | 150 A                                | 192 A                                | 232 A                                |
| Wire Cross Section                 | 16 mm <sup>2</sup>  | 35 mm <sup>2</sup>  | 50 mm <sup>2</sup>                   | 70 mm <sup>2</sup>                   | 70 mm <sup>2</sup>                   |
| <b>UR / cUR Technical Data</b>     |                     |                     |                                      |                                      |                                      |
| Nominal Voltage                    | 1000 V              | 1000 V              | 1000 V                               | 1000 V                               | 1000 V                               |
| Nominal Current                    | 85 A                | 115 A               | 150 A                                | 175 A                                | 175 A                                |
| Wire Cross Section                 | 12 - 4 AWG          | 12-2 AWG            | 6-1/0 AWG                            | 6-2/0 AWG                            | 6-2/0 AWG                            |
| <b>Connection Data</b>             |                     |                     |                                      |                                      |                                      |
| Minimum solid strand cross section | 2.5 mm <sup>2</sup> | 1.5 mm <sup>2</sup> | 16 mm <sup>2</sup>                   | 10 mm <sup>2</sup>                   | 25 mm <sup>2</sup>                   |
| Maximum solid Strand cross section | 25 mm <sup>2</sup>  | 35 mm <sup>2</sup>  | 70 mm <sup>2</sup>                   | 70 mm <sup>2</sup>                   | 95 mm <sup>2</sup>                   |
| Minimum fine Strand cross section  | 4 mm <sup>2</sup>   | 1.5 mm <sup>2</sup> | 16 mm <sup>2</sup>                   | 16 mm <sup>2</sup>                   | 35 mm <sup>2</sup>                   |
| Maximum fine strand cross section  | 25 mm <sup>2</sup>  | 35 mm <sup>2</sup>  | 50 mm <sup>2</sup>                   | 70 mm <sup>2</sup>                   | 95 mm <sup>2</sup>                   |
| AWG Conductor Range                | 12 - 4              | 12-2                | 6 - 1/0                              | 6 - 2/0                              | 6 - 2/0                              |
| Connection Type                    | screw (1,0x5,5)     | screw (1.2x6,5)     | hexagonal socket screw S5 (DIN 6911) | hexagonal socket screw S6 (DIN 6911) | hexagonal socket screw S6 (DIN 6911) |
| Insulation Stripping length        | 16 mm               | 18 mm               | 24 mm                                | 24 mm                                | 24 mm                                |
| Tightening torque                  | 1,2 - 2,0 Nm        | 2,5 - 3,5 Nm        | 6,0 - 10 Nm                          | 6,0 - 12 Nm                          | 6,0 - 12 Nm                          |

## IMO Worldwide Offices

### IMO Precision Controls Limited

The Interchange  
Frobisher Way  
Hatfield, Herts AL10 9TG  
United Kingdom

Tel: 01707 414 444

Email: [imo@imopc.com](mailto:imo@imopc.com)  
Web: [www.imopc.com](http://www.imopc.com)

### IMO Jeambrun Automation SAS

Parc de la Broye  
14 rue du Chafour  
59710 ENNEVELIN  
France

Tel: 0800 912 712 (n° gratuit)

Email: [imo-fr@imopc.com](mailto:imo-fr@imopc.com)  
Web: [www.imojeambrun.fr](http://www.imojeambrun.fr)

### IMO Automazione

Via Belfiore 10,  
50144 Firenze (FI)  
Italia

Tel: 800 930 872 (toll free)

Email: [imo-it@imopc.com](mailto:imo-it@imopc.com)  
Web: [www.imopc.it](http://www.imopc.it)

### IMO Canada

1B-701 Rossland Road East  
Suite #608  
Whitby, Ontario L1N 9K3  
Canada

Tel: 416 639 0709

Email: [sales-ca@imopc.com](mailto:sales-ca@imopc.com)  
Web: [www.imopc.com](http://www.imopc.com)

### IMO Automation LLC

Steeplechase Industrial Park  
Suite E, 5845 Steeplechase Blvd  
Cumming, GA 30040  
USA

Tel: 404 476 8810

Email: [sales-na@imopc.com](mailto:sales-na@imopc.com)  
Web: [www.imoautomation.com](http://www.imoautomation.com)

### IMO South Africa (Pty) Ltd

Unit 2 Trio Park  
Prime Park, Printers Way  
Cape Town 7441  
South Africa

Tel: 021 551 1787

Email: [info@imopc.co.za](mailto:info@imopc.co.za)  
Web: [www.imopc.co.za](http://www.imopc.co.za)

### IMO Pacific Pty Ltd

Unit 9, Dillington Pass  
Landsdale  
Perth WA 6065  
Australia

Tel: 1300 34 21 31

Email: [sales@imopacific.com.au](mailto:sales@imopacific.com.au)  
Web: [www.imopacific.com.au](http://www.imopacific.com.au)



**LinkedIn**  
Connect with us and follow  
IMO Precision Controls for the  
latest news, views and reviews



Errors and omissions excepted. Subject to change without notice. Information correct at time of print.