



ATORPLED2X6/M3



Features

Exceeds performance of standard T5 fluorescent.

Ultra slim IP65 LED NCF linear.

Unique base design caters for multiple installation methods.

Installer friendly imbedded features aid accurate and fast installation for any application.

Quick release LED array/gear tray assembly provides the installer the means to faster installation/maintenance.

Fast latching/permanently located stainless steel side clips ensure a quick and secure connection.

Tridonic LED driver as standard.

LED lifespan L80 B10 54,000 hours

Self-test emergency as standard with Li-ion battery technology, reducing charge time and running costs.

General Information

Lamp Type	LED
Emergency	Yes
Self Test	Yes
IP Rating	IP65
IK Rating	IK07
Class Protection	1
Internal / External	Internal/External
Surface / Recessed / Suspended	Surface/Suspended
Warranty (Years)	7
CE Mark	Yes
Length (mm)	1865
Width (mm)	115
Height (mm)	70

Technical Information

Wattage	78W
Lumens Delivered	8204lm
Lm/W	105lm
CRI	Ra 80
CCT	4000K
Input	230V
Hertz	50Hz
Operating Temp	-10°C to 40°C

Technical Data - ETIM - Ceiling-/wall luminaire (EC002892)

Suitable for wall mounting	No
Suitable for suspended mounting	Yes
Suitable for ceiling mounting	Yes
Suitable for built-in mounting	No
Suitable for surface mounting	Yes
With light source	Yes
Material housing	Plastic
Colour housing	Grey
Material cover	Plastic, opal
Nominal voltage	230-230 V
Control gear included	Yes
No dim function	Yes
Degree of protection (IP)	IP65
Impact strength	IK07
Protection class	I
Suitable for emergency lighting	Yes
With movement sensor	No
With light sensor	No
Max. system power	78 W
Rated luminous flux acc. IEC 62722-2-1	8204 lm
Colour of light	White
Colour temperature	4000-4000 K
Colour rendering index CRI	80-89
Luminaire efficacy	105 lm/W
Width	115 mm

Height/depth	70 mm
Length	1865 mm

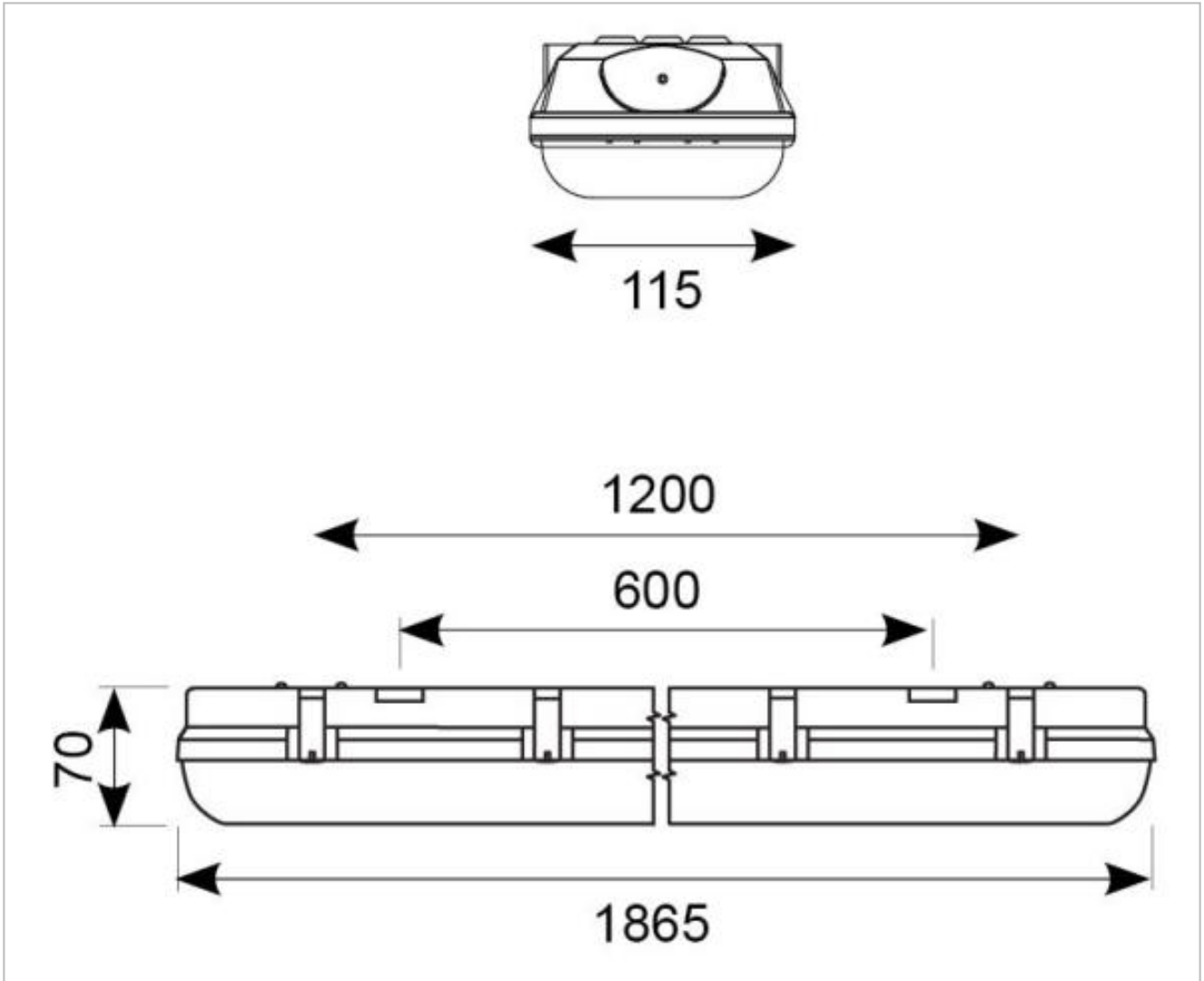

Datasheet generated from <https://onetimepim.com> last updated Monday, September 6, 2021 2:00:39 PM